

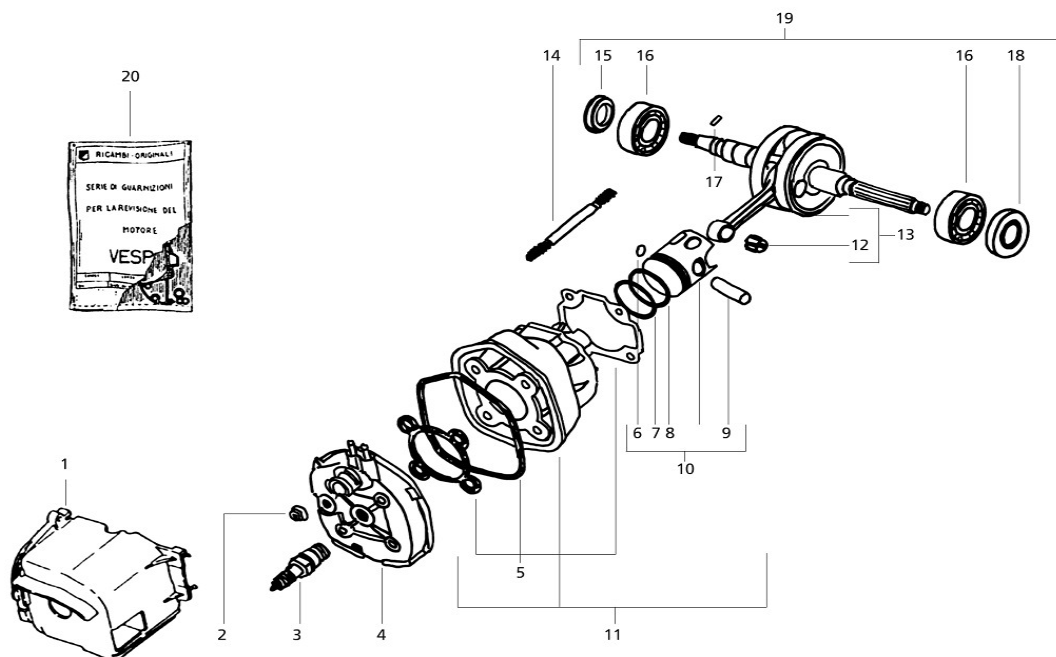







































E501 Engine MINARELLI - Cylinder & Crankshaft











	Prod.no.	Product name	Gross Price
1	R142560020	Cylinder Cowling for MINARELLI vertical AC	14,20 EUR
1	R142560010	Cylinder Cowling for MINARELLI horizontal AC	13,50 EUR
2	88840000	Nut M6 mm, 8, steel, zinc plated, AF 10mm, self-locking polyamide wedge	0,30 EUR
2	R121850200	Nut M7x1 mm, 8, steel, zinc plated, AF 11mm, PIAGGIO, cylinder head, (4), for MINARELLI, outlet for PIAGGIO Leader /Quasar/LEM/iGet 125-300ccm 4T AC/LC, (2) with edge Grade A - perfect repair	1,40 EUR
2	R121850205	Nut M7x1 mm, 8, steel, zinc plated, AF 10mm, cylinder head, (4), for MINARELLI, outlet for PIAGGIO Leader /Quasar/LEM/iGet 125-300ccm 4T AC/LC, (2) with edge Grade A - perfect repair	1,00 EUR
3	NGKBR7HS	Spark Plug NGK BR7HS, copper M14x1,25, wrench width 20,8mm, interference suppressed/short thread	4,50 EUR
3	88010000	Spark Plug DENSO W27ES-U, copper M14x1,25, wrench width 20,8mm, long thread similar to BOSCH W2CC/W3CC/ NGK B9ES	3,90 EUR
4	R100070030	Cylinder Head 50 cc for MINARELLI horizontal AC Grade B - decent repair	21,90 EUR

4		R100070050	Cylinder Head 50 cc for MINARELLI horizontal LC incl. 2 brass connections, Grade B - decent repair	29,00 EUR
4		R100070040	Cylinder Head 50 cc for MINARELLI vertical AC Grade B - decent repair	29,00 EUR
5		R100689020	Gasket Set RMS for cylinder R100080050 50 cc for MINARELLI horizontal LC	6,50 EUR
5		R100689010	Gasket Set RMS for cylinder R100080030 50 cc for MINARELLI horizontal AC	6,20 EUR
5		R100689000	Gasket Set RMS for cylinder R100080040 50 cc for MINARELLI vertical AC	6,20 EUR
6		MET1006	Gudgeon Pin Clip METEOR Ø 10x1 mm, Circlip	1,60 EUR
7/8		R100100030	Piston Rings RMS 50 cc, for MINARELLI 2-stroke AC/LC	10,70 EUR
10		MET1278	Piston METEOR for MINARELLI all models Ø 40,0mm, pin Ø=10mm, Grade B - decent repair	25,90 EUR
11		R10008005	Cylinder Kit RMS 50 cc for MINARELLI horizontal 50cc 2-Stroke LC 2T LC Ø 40,0mm, cast iron, 2 piston ring(s), pin 10mm, w/o cylinder head, Grade B - decent repair	99,00 EUR
11		R10008003	Cylinder Kit RMS 50 cc for MINARELLI horizontal 50cc 2T AC Ø 40,0mm, cast iron, 2 piston ring(s), pin 10mm, w/o cylinder head, Grade A - perfect repair	75,00 EUR
11		R10008004	Cylinder Kit RMS 50 cc for MINARELLI vertical 50cc 2-Stroke AC 2T AC Ø 40,0mm, cast iron, 2 piston ring(s), pin 10mm, w/o cylinder head, Grade B - decent repair	69,00 EUR
12		R100150010	Gudgeon Pin Bearing for HONDA/SUZUKI/MINARELLI 10x14x13 mm	5,90 EUR
13		R100010030	Crankshaft RMS for MINARELLI horizontal 50cc 2-Stroke AC/LC, pin 10mm, Grade C - low-priced repairs	75,00 EUR
13		R100010050	Crankshaft RMS for MINARELLI AM345-AM6 50cc	99,00 EUR
13		R100010010	Crankshaft RMS for MINARELLI vertical 50cc 2-Stroke AC, pin 10mm, Grade C - low-priced repairs	79,00 EUR
14		R121856030	Cylinder Stud M7x109 mm, for MINARELLI horizontal	1,90 EUR

14		87111000	Cylinder Stud M6x107 mm, RMS for GILERA/PIAGGIO/MINARELLI vertical 50cc 2-Stroke AC/LC	2,40 EUR
15		R100661900	Oil Seal crankshaft flywheel side for MINARELLI 20x30x33,5x6 mm	3,10 EUR
16		M6616872E	Bearing Set crankshaft for PIAGGIO CIAO/PX/SI/Bravo /Superbravo/Grillo/Boss 50ccm 2T AC, MALOSSI, C3, 15x35x11 mm, 2 pcs	27,90 EUR
16		90030000	Bearing Crankshaft flywheel side for Vespa 50 2°/N/L/R/S 2° /Special/SR/SS/PK50/S/SS/XL /XL2/Ape 50, drive shaft wheelside for Vespa 50-125/PV/ET3/PK/XL/XL2 /125 VNA-TS/150 VBA-Super /Rally/PX80-200/PE/Lusso 1° crankshaft for MINARELLI SKF, C3, 20x47x14 mm	9,50 EUR
16		M6615137E	Bearing Set crankshaft for MINARELLI horizontal /vertical 2-stroke AC/LC crankshaft flywheel side MALOSSI MHR, C4H, 20x47x14 mm, 2 pcs	22,00 EUR
16		M6611566E	Bearing Set crankshaft for MINARELLI horizontal /vertical 2-stroke AC/LC MALOSSI MHR, C3H, with polyamide cage, 20x47x14 mm, 2 pcs, Ø ball: 9,525mm	24,90 EUR
16		M6611566B	Bearing crankshaft flywheel side for Vespa 50 2°/N/L/R/S 2° /Special/SR/SS/PK50/S/SS/XL /XL2/Ape 50, drive shaft wheelside for Vespa 50-125/PV/ET3/PK/XL/XL2 /125 VNA-TS/150 VBA-Super /Rally/PX80-200/PE/Lusso 1° MALOSSI MHR, C3H, with polyamide cage, 20x47x14 mm, Ø ball: 9,525mm	11,90 EUR
16		90131500	Bearing Crankshaft flywheel side for Vespa 50 2°/N/L/R/S 2° /Special/SR/SS/PK50/S/SS/XL /XL2/Ape 50, crankshaft for MINARELLI /PIAGGIO 50ccm AC/LC SKF, C5, 20x47x14 mm	9,50 EUR
16		6204C4	Bearing Crankshaft for MINARELLI 50cc drive shaft wheelside for GILERA/PIAGGIO 50-180ccm for Vespa 50-125/PV/ET3/PK/XL /XL2/125 VNA-TS/150 VBA -Super/Rally/PX80-200/PE /Lusso 1° SKF, C4, 20x47x14 mm	10,90 EUR

16		M6616065B	Bearing crankshaft flywheel side for Vespa 50 2°/N/L/R/S 2° /Special/SR/SS/PK50/S/SS/XL /XL2/Ape 50, drive shaft wheelside for Vespa 50-125/PV/ET3/PK/XL/XL2 /125 VNA-TS/150 VBA-Super /Rally/PX80-200/PE/Lusso 1° MALOSSİ MHR, C4, with polyamide cage, 20x47x14 mm, Ø ball: 7,938mm	15,90 EUR
17		87050000	Woodruff Key input shaft /clutch, for Vespa 50-125/PV /ET3/PK50-125/S/XL/XL2 3x3x10 mm, BUZZETTI, MINARELLI all models	1,20 EUR
18		R100662300	Oil Seal crankshaft variomatic side for MINARELLI 20x42x43x8x9 mm	2,90 EUR
19		R100200340	Bearing Crankshaft for MINARELLI horizontal /vertical 20x47x14 mm, drive shaft PIAGGIO/GILERA, incl. oil seals	21,00 EUR
19		C16186KTC4	Bearing Crankshaft for MINARELLI AC/LC 20x47x14 mm, 2 pieces, incl. oil seals	27,00 EUR
19		P2820002	Bearing/Oil Seal Set cranksh.. ..aft for MINARELLI 50cc 2-Stroke AC /LC POLINI, PTFE, 20x52x12 mm, 2 pieces, incl. oil seals (18x28x7; 19x30x7)	29,90 EUR
20		R100641010	Oil Seal Set for MINARELLI horizontal /vertical	19,50 EUR
98		14235000	Brake Cleaner SIP 500ml, spray	4,50 EUR
98		14131000	Skin Cleaner "Fast Orange", 440ml	8,10 EUR
98		14130000	Skin Cleaner LOCTITE SF 7850, 400ml	12,20 EUR
98		92112000	Sealing Compound REINZ Engine, REINZOPLAST 300 PU, blue, 80ml	14,90 EUR
98		14110000	Hand Cleaner (paste) TEROSON /HENKEL 300g	6,40 EUR
98		92111000	Sealing Compound REINZ Engine, REINZOSIL 300 SI, anthracite, 70ml	14,90 EUR
98		81103000	Sealing Remover REINZ 300ml	13,90 EUR
98		14104000	Oil Seal Glue LOCTITE "542", medium strength, brown, 10ml	16,70 EUR

98		14100000	Thread Locker LOCTITE "243", medium strength, blue, 5ml	11,20 EUR
98		14230000	Brake Cleaner MASTERCARE /REPSTAR 500ml, spray	3,50 EUR
99A		15194000	Tool BUZZETTI gudgeon pin, installation, removal, Ø 13, 15, 16, 19, 22mm	69,00 EUR
99A		83002100	Ignition Timing Degree Disc SIP for ignition adjustment, for Vespa/Lambretta/Scooter /Maxiscooter plastic, Grade A - perfect repair	20,00 EUR
99A		15199005	Balancing Block HESOTEC for crankshaft/flywheel for Vespa with steel bearing	129,00 EUR
99A		83008050	Adaptor SIP for SIP/PINASCO degree disc holder, for Vespa PK50-125 2°/S 2°/XL/XL2/125 GTR 2°/150 TS 2°/Sprint V 2° /Super 2°/200 Rally 2°/PX80 -200/PE/Lusso/Cosa/T5 M12x1,25 mm, h collar 15,0 mm, Ø 19,5 mm, don't forget the knurled screw!	12,00 EUR
99A		18119000	Tool SIP assembly output shaft / crankshaft, for Vespa 50-125 /PV/ET3/PK50-125/S/XL/XL2 /125 V1-GTR 2°/TS 2°/150 VL -Sprint V2° /Super 2°/PX80 -200/PE/Lusso/'98/MY/'11/T5 /Cosa M16x1,25, M14x1,5, M12x1,5, M12x1,25, RH M10x1,5, LH M10x1,5 mm, 10-parts	69,00 EUR
99B		MXMG05L	Gloves Mechanix The Original, black, unisex, size L, 60% nylon, 35% polyurethan, 5% elastane	29,90 EUR
99B		12194000	Knee Pad SIP 435x195x30 mm, foam EVA, black /red	10,20 EUR