

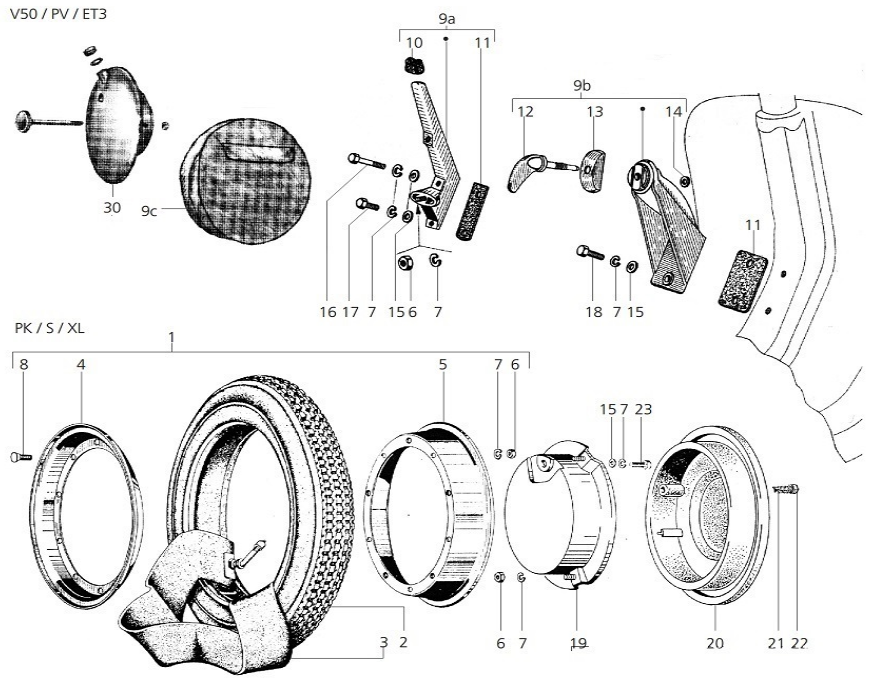

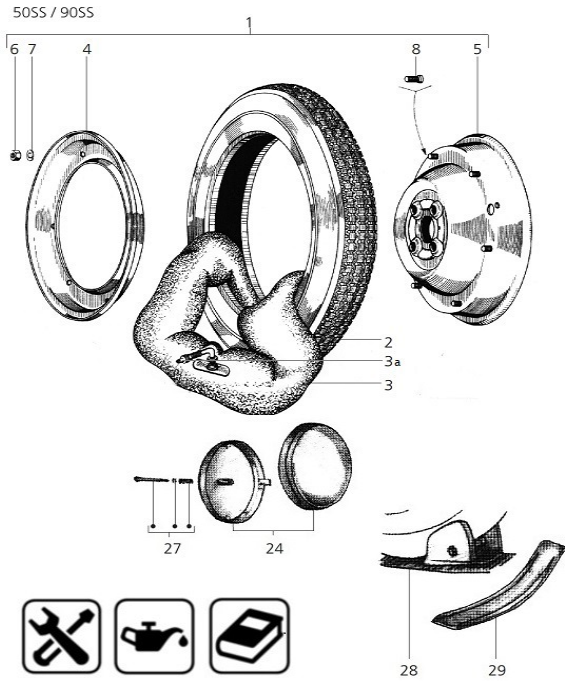





















T17c Tyre, Rim & Spare Wheel Cover





| | | Prod.no. | Product name | Gross Price |
|---|---|----------|--|-------------|
| 1 |  | 75996100 | Rim Lock for all 10" rim, for Vespa V50/PV/ET3 PK/S/XL /PX/T5/Rally/Sprint/ Veloce | 27,00 EUR |
| 1 |  | 81031000 | Rim for Vespa 50-125/PV/ET3/PK /S/XL/XL2/125 GT-TS/150 GL /GS VS5T/Sprint/V/T4/Rally /PX/PE/Lusso/T5/LML Star/DLX /Deluxe 2T/4T, 2.10-10", open, titanium grey | 19,00 EUR |
| 1 |  | 81015000 | Rim Tubeless SIP for Vespa 50-125/PV/ET3/PK/S/XL/XL2/125 GT-TS/150 GL/GS VS5T/Sprint /V/T4/Rally/PX/PE/Lusso/T5 /Cosa/LML Star/DLX/Deluxe 2T /4T, 2.50-10", open, anti-theft protection, front & rear, aluminium, pol.. ..ished, KBA 50163, valve premounted, Grade AA - for a first-class repair | 69,00 EUR |
| 1 |  | 80120000 | Rim FA for Vespa 50 S/SR /Sprinter/Revival/90/100 1°, also for Vespa 50 N/L/R ->V5A1T 752188 als Umrüstfelge 9" auf 10", 2.10-10", closed, grey, 4-hole, nut M8, wrench 13 | 29,00 EUR |
| 1 |  | 81007000 | Rim "RACING" for Vespa 50-125 /PV/ET3/PK/S/XL/XL2/125 GT -TS/150 GL/GS VS5T/Sprint/V /T4/Rally/PX/PE/Lusso/T5/LML Star/DLX/Deluxe 2T/4T, 2.10-10", open, chrome, w/o ABE | 45,00 EUR |
| 1 |  | 82005000 | Rim 9" to 10" conversion rim for Vespa 50 R 752189->V5A2T /V5A3T, 2.10-10", open, silver, nut M8, wrench 13 | 29,00 EUR |

| | | | | |
|---|---|----------|--|------------|
| 1 |  | 81020500 | Rim "Lambretta Style" for Vespa 50-125/PV/ET3/PK/S/XL/XL2/125 GT-TS/150 GL/GS VS5T/Sprint/V/T4/Rally/PX/PE/Lusso/T5/LML Star/DLX/Deluxe 2T/4T, 2.10-10", open, chrome, with cut outs for u-lock | 65,00 EUR |
| 1 |  | 83038000 | Rim Tubeless SIP for Vespa 50 S/SR/Sprinter/Revival/90/100 1°, also for Vespa 50 N/L/R ->V5A1T 752188 als Umrüstfelge 9" auf 10", 2.15-10", closed, matt black with polished edge, 4-hole, Grade AA - for a first-class repair | 69,00 EUR |
| 1 |  | 80122000 | Rim FA for Vespa 50 S/SR/Sprinter/Revival/90/100 1°, also for Vespa 50 N/L/R ->V5A1T 752188 als Umrüstfelge 9" auf 10", 2.10-10", closed, chrome, 4-hole, nut M8, wrench 13 | 49,00 EUR |
| 1 |  | 81033000 | Rim SIP for Vespa 50-125/PV/ET3/PK/S/XL/XL2/125 GT-TS/150 GL/GS VS5T/Sprint/V/T4/Rally/PX/PE/Lusso/T5/LML Star/DLX/Deluxe 2T/4T, 2.10-10", open, matt black, as a nice accessory | 22,50 EUR |
| 1 |  | 81019000 | Rim Tubeless SIP for Vespa 50-125/PV/ET3/PK/S/XL/XL2/125 GT-TS/150 GL/GS VS5T/Sprint/V/T4/Rally/PX/PE/Lusso/T5/Cosa/LML Star/DLX/Deluxe 2T/4T, 2.50-10", open, anti-theft protection, front & rear, white, KBA 50163, valve premounted, Grade AA - for a first-class repair | 69,00 EUR |
| 1 |  | 83057200 | Rim Tubeless Wide Tyre SIP for Vespa 50-125/PV/ET3/PK/S/XL/XL2/125 GT-TS/150 GL/GS VS5T/Sprint/V/T4/Rally/PX/PE/Lusso/T5/Cosa/LML Star/DLX/Deluxe 2T/4T, for 110/70-11" tyres, 2.50-11", open, front & rear, silver matt, valve premounted, Grade AA - for a first-class repair | 82,00 EUR |
| 1 |  | 81063100 | Rim Tubeless 2.0 SIP for Vespa 50-125/PV/ET3/PK/S/XL/XL2/125 GT-TS/150 GL/GS VS5T/Sprint/V/T4/Rally/PX/PE/Lusso/T5/LML Star/DLX/Deluxe 2T/4T, 2.10-10", open, anti-theft protection, front & rear, aluminium, chr..ome, KBA 51612, valve premounted, Grade AA - for a first-class repair | 109,00 EUR |













| | | | | |
|---|--|----------|--|-----------|
| 1 |  | 81005000 | Rim "RUSH" for Vespa 50-125/PV/ET3/PK/S/XL/XL2/125 GT-TS/150 GL/GS VS5T/Sprint/V/T4/Rally/PX/PE/Lusso/T5/LML Star/DLX/Deluxe 2T/4T, 2.10-10", open, aluminium, chrome, w/o ABE | 40,00 EUR |
| 1 |  | 81023100 | Rim for Vespa 50-125/PV/ET3/PK/S/XL/XL2/125 GT-TS/150 GL/GS VS5T/Sprint/V/T4/Rally/PX/PE/Lusso/T5/LML Star/DLX/Deluxe 2T/4T, 2.15-10", open, front & rear, custom chrome | 49,00 EUR |
| 1 |  | 81064100 | Rim Tubeless 2.0 SIP for Vespa 50-125/PV/ET3/PK/S/XL/XL2/125 GT-TS/150 GL/GS VS5T/Sprint/V/T4/Rally/PX/PE/Lusso/T5/LML Star/DLX/Deluxe 2T/4T, 2.10-10", open, anti-theft protection, front & rear, aluminium, red, KBA 51612, valve premounted, Grade AA - for a first-class repair | 69,00 EUR |
| 1 |  | 83058000 | Rim Tubeless Wide Tyre SIP for Vespa 50-125/PV/ET3/PK/S/XL/XL2/125 GT-TS/150 GL/GS VS5T/Sprint/V/T4/Rally/PX/PE/Lusso/T5/Cosa/LML Star/DLX/Deluxe 2T/4T, for 110/70-11" tyres, 2.50-11", open, front & rear, matt black with polished edge, valve premounted, Grade AA - for a first-class repair | 82,00 EUR |
| 1 |  | 81000000 | Rim SIP for Vespa 50-125/PV/ET3/PK/S/XL/XL2/125 GT-TS/150 GL/GS VS5T/Sprint/V/T4/Rally/PX/PE/Lusso/T5/LML Star/DLX/Deluxe 2T/4T, 2.10-10", open, silver, Grade AA - for a first-class repair | 19,90 EUR |
| 1 |  | 81018000 | Rim Tubeless SIP for Vespa 50-125/PV/ET3/PK/S/XL/XL2/125 GT-TS/150 GL/GS VS5T/Sprint/V/T4/Rally/PX/PE/Lusso/T5/Cosa/LML Star/DLX/Deluxe 2T/4T, 2.50-10", open, anti-theft protection, front & rear, aluminium, matt black with polished edge, KBA 50163, valve premounted, Grade AA - for a first-class repair | 69,00 EUR |









| | | | | |
|---|---|----------|--|-----------|
| 1 |  | 83055000 | Rim Tubeless Wide Tyre SIP for Vespa 50-125/PV/ET3/PK/S/XL/XL2/125 GT-TS/150 GL/GS VS5T/Sprint/V/T4/Rally/PX/PE/Lusso/T5/Cosa/LML Star/DLX/Deluxe 2T/4T, for 110/70-11" tyres, 2.50-11", open, front & rear, aluminium polished, valve premounted, Grade AA - for a first-class repair | 82,00 EUR |
| 1 |  | 83035000 | Rim Tubeless SIP for Vespa 50 S/SR/Sprinter/Revival/90/100 1°, also for Vespa 50 N/L/R ->V5A1T 752188 als Umrüstfelge 9" auf 10", 2.15-10", closed, aluminium polished, 4-hole, Grade AA - for a first-class repair | 69,00 EUR |
| 1 |  | 81017000 | Rim Tubeless SIP for Vespa 50-125/PV/ET3/PK/S/XL/XL2/125 GT-TS/150 GL/GS VS5T/Sprint/V/T4/Rally/PX/PE/Lusso/T5/Cosa/LML Star/DLX/Deluxe 2T/4T, 2.50-10", open, anti-theft protection, front & rear, aluminium, silver, KBA 50163, valve premounted, Grade AA - for a first-class repair | 69,00 EUR |
| 1 |  | 83039000 | Rim Tubeless SIP for Vespa 50 S/SR/Sprinter/Revival/90/100 1°, also for Vespa 50 N/L/R ->V5A1T 752188 als Umrüstfelge 9" auf 10", 2.15-10", closed, red, 4-hole, Grade AA - for a first-class repair | 65,00 EUR |
| 1 |  | 81065100 | Rim Tubeless 2.0 SIP for Vespa 50-125/PV/ET3/PK/S/XL/XL2/125 GT-TS/150 GL/GS VS5T/Sprint/V/T4/Rally/PX/PE/Lusso/T5/LML Star/DLX/Deluxe 2T/4T, 2.10-10", open, anti-theft protection, front & rear, aluminium, polished, KBA 51612, valve premounted, Grade AA - for a first-class repair | 69,00 EUR |
| 1 |  | 81001000 | Rim PIAGGIO for Vespa 50-125/PV/ET3/PK/S/XL/XL2/125 GT-TS/150 GL/GS VS5T/Sprint/V/T4/Rally/PX/PE/Lusso/T5/LML Star/DLX/Deluxe 2T/4T, 2.10-10", open, silver, with emblem, doesn't fit in connection with GRIMECA Classic NT disc brake, Grade B - decent repair | 30,00 EUR |

| | | | | |
|---|--|----------|---|------------|
| 1 |  | 81020000 | Rim SIP for Vespa 50-125/PV/ET3/PK/S/XL/XL2/125 GT-TS/150 GL/GS VS5T/Sprint/V/T4/Rally/PX/PE/Lusso/T5/LML Star/DLX/Deluxe 2T/4T, 2.10-10", open, chrome | 27,00 EUR |
| 1 |  | 81016000 | Rim Tubeless SIP for Vespa 50-125/PV/ET3/PK/S/XL/XL2/125 GT-TS/150 GL/GS VS5T/Sprint/V/T4/Rally/PX/PE/Lusso/T5/Cosa/LML Star/DLX/Deluxe 2T/4T, 2.50-10", open, anti-theft protection, front & rear, matt black, KBA 50163, valve premounted, Grade AA - for a first-class repair | 69,00 EUR |
| 1 |  | 75996200 | Rim Lock spare wheel, for Vespa 50-125/PV/ET3/PK/XL/XL2/125 GT/GTR/TS/Super/150 GL/Sprint/V/Super/160 GS/180 SS/Rally/PX/T5/Cosa M8 mm | 11,90 EUR |
| 1 |  | C1019000 | Rim Look CARBONE for Vespa 50-125/PV/ET3/PK/S/XL/XL2/125 GT-TS/150 GL/GS VS5T/Sprint/V/T4/Rally/PX/PE/Lusso/T5/LML Star/DLX/Deluxe 2T/4T | 100,00 EUR |
| 1 |  | 81069100 | Rim Tubeless 2.0 SIP for Vespa 50-125/PV/ET3/PK/S/XL/XL2/125 GT-TS/150 GL/GS VS5T/Sprint/V/T4/Rally/PX/PE/Lusso/T5/LML Star/DLX/Deluxe 2T/4T, 2.10-10", open, anti-theft protection, front & rear, aluminium, white brilliant, KBA 51612, valve premounted, Grade AA - for a first-class repair | 69,00 EUR |
| 1 |  | 81066100 | Rim Tubeless 2.0 SIP for Vespa 50-125/PV/ET3/PK/S/XL/XL2/125 GT-TS/150 GL/GS VS5T/Sprint/V/T4/Rally/PX/PE/Lusso/T5/LML Star/DLX/Deluxe 2T/4T, 2.10-10", open, anti-theft protection, front & rear, aluminium, matt black, KBA 51612, valve premounted, Grade AA - for a first-class repair | 69,00 EUR |
| 1 |  | 83057000 | Rim Tubeless Wide Tyre SIP for Vespa 50-125/PV/ET3/PK/S/XL/XL2/125 GT-TS/150 GL/GS VS5T/Sprint/V/T4/Rally/PX/PE/Lusso/T5/Cosa/LML Star/DLX/Deluxe 2T/4T, for 110/70-11" tyres, 2.50-11", open, front & rear, silver, valve premounted, Grade AA - for a first-class repair | 75,00 EUR |
| 1 |  | 60525247 | Rim Lock ABUS also for SIP tubless rims with anti-theft protection, black, l 1850 mm, Ø 10 mm | 45,00 EUR |













| | | | | |
|---|---|----------|--|-----------|
| 1 |  | 81043000 | Rim "Special" SIP for Vespa 50-125/PV/ET3/PK/S/XL/XL2/125 GT-TS/150 GL/GS VS5T/Sprint /V/T4/Rally/PX/PE/Lusso/T5 /Cosa/LML Star/DLX/Deluxe 2T /4T, for 100'80/100'90-10" tyres, open, grey | 25,00 EUR |
| 1 |  | 83037200 | Rim Tubeless SIP for Vespa 50 S/SR/Sprinter/Revival/90 /100 1°, also for Vespa 50 N/L /R ->V5A1T 752188 als Umrüstfelge 9" auf 10", 2.15-10", closed, silver matt, 4-hole, Grade AA - for a first-class repair | 69,00 EUR |
| 1 |  | 81021000 | Rim FA for Vespa 50 N/L/R ->V5A1T 752188, 1.80-9", closed, grey, 4-hole, nut M8, wrench 13 | 29,00 EUR |
| 1 |  | 81067100 | Rim Tubeless 2.0 SIP for Vespa 50-125/PV/ET3/PK/S/XL/XL2/125 GT-TS/150 GL/GS VS5T/Sprint /V/T4/Rally/PX/PE/Lusso/T5 /LML Star/DLX/Deluxe 2T/4T, 2.10-10", open, anti-theft protection, front & rear, aluminium, sil.. ..ver, KBA 51612, valve premounted, Grade AA - for a first-class repair | 69,00 EUR |
| 1 |  | 81002000 | Rim "CERES" for Vespa 50-125 /PV/ET3/PK/S/XL/XL2/125 GT -TS/150 GL/GS VS5T/Sprint/V /T4/Rally/PX/PE/Lusso/T5/LML Star/DLX/Deluxe 2T/4T, 2.10-10", open, black with polished edge, w/o ABE | 45,00 EUR |
| 1 |  | 80160000 | Rim FA for Vespa 50 R 752189-> /Special/V5A2T/V5A3T, 1.80-9", open, grey, nut M8, wrench 13 | 30,00 EUR |
| 1 |  | 81067200 | Rim Tubeless 2.0 SIP for Vespa 50-125/PV/ET3/PK/S/XL/XL2/125 GT-TS/150 GL/GS VS5T/Sprint /V/T4/Rally/PX/PE/Lusso/T5 /LML Star/DLX/Deluxe 2T/4T, 2.10-10", open, anti-theft protection, front & rear, aluminium, sil.. ..ver matt, KBA 51612, valve premounted, Grade AA - for a first-class repair | 69,00 EUR |
| 1 |  | 83037000 | Rim Tubeless SIP for Vespa 50 S/SR/Sprinter/Revival/90 /100 1°, also for Vespa 50 N/L /R ->V5A1T 752188 als Umrüstfelge 9" auf 10", 2.15-10", closed, silver, 4-hole, Grade AA - for a first-class repair | 72,00 EUR |













| | | | | |
|---|---|----------|---|------------|
| 1 |  | 81017200 | Rim Tubeless SIP for Vespa 50-125/PV/ET3/PK/S/XL/XL2/125 GT-TS/150 GL/GS VS5T/Sprint /V/T4/Rally/PX/PE/Lusso/T5 /Cosa/LML Star/DLX/Deluxe 2T /4T, 2.50-10", open, anti-theft protection, front & rear, aluminium, sil.. ..ver matt, KBA 50163, valve premounted, Grade AA - for a first-class repair | 69,00 EUR |
| 1 |  | 75996500 | Rim Lock SERIE PRO for open 10" rim, for Vespa 50 Special V5B1-4T /SR/SS/90 R/SS/100 2°/125/PV /ET3/P80/E (FR) incl. disc lock 70mm | 59,00 EUR |
| 1 |  | 81034000 | Rim for Vespa 50-125/PV/ET3/PK /S/XL/XL2/125 GT-TS/150 GL /GS VS5T/Sprint/V/T4/Rally /PX/PE/Lusso/T5/LML Star/DLX /Deluxe 2T/4T, 2.10-10", open, white brillant | 18,70 EUR |
| 1 |  | 80121000 | Rim PIAGGIO for Vespa 50 S/SR /Sprinter/Revival/90/100 1°, also for Vespa 50 N/L/R ->V5A1T 752188 als Umrüstfelge 9" auf 10", 2.10-10", closed, grey, 4-hole, nut M8, wrench 11 | 62,00 EUR |
| 1 |  | 81068100 | Rim Tubeless 2.0 SIP for Vespa 50-125/PV/ET3/PK/S/XL/XL2/125 GT-TS/150 GL/GS VS5T/Sprint /V/T4/Rally/PX/PE/Lusso/T5 /LML Star/DLX/Deluxe 2T/4T, 2.10-10", open, anti-theft protection, front & rear, aluminium, matt black with polished edge, KBA 51612, valve premounted, Grade AA - for a first-class repair | 69,00 EUR |
| 1 |  | 8102310G | Rim for Vespa 50-125/PV/ET3/PK /S/XL/XL2/125 GT-TS/150 GL /GS VS5T/Sprint/V/T4/Rally /PX/PE/Lusso/T5/LML Star/DLX /Deluxe 2T/4T, 2.15-10", open, front & rear, custom chrome, 2nd quality, with minor scratches/little bit rusty | 35,00 EUR |
| 2 |  | 30706000 | Tyre SIP Classic, 3.00-10", 50P, ECE-R75, KBA 51612, mounted on rim: SIP 2.10-10", tubeless, aluminium, polished, mounted, ready to go, up to 150km/h classic tyre | 109,00 EUR |
| 2 |  | 80301100 | Tyre PIRELLI SC 30, 3.00-10", 42J, TT, profile: classic, classic tyre | 32,00 EUR |
| 2 |  | 1975705 | Whitewall Tyre MITAS MC12, 3.00-10", 42J, TL/TT, profile: sport, sport tyre | 49,00 EUR |





| | | | | |
|---|---|----------|---|------------|
| 2 |  | 80051200 | Tyre CONTINENTAL TWIST, 3.00-10", 50M, TL, M/C, reinforced, profile: sport, sport tyre | 45,00 EUR |
| 2 |  | 79860000 | Tyre SIP Classic, 3.00-10", 50P, TL/TT, with ECE norm, up to 150 km/h profile: classic, classic tyre for tuned engines | 32,00 EUR |
| 2 |  | 80222000 | Tyre PIRELLI SL 26, 90/90-10", 50J, TL, profile: sport, sport tyre | 37,00 EUR |
| 2 |  | 30402100 | Tyre CONTINENTAL TWIST, 3.00-10", 50M, M/C, reinforced, rear, KBA 51612, mounted on rim: SIP 2.0 2.10 -10", tubeless, aluminium, black with polished edge, mounted, ready to go! | 119,00 EUR |
| 2 |  | VE396160 | Tyre VEE RUBBER MANHATTEN VRM396, 3.00-10", 42J, TL, profile: sport, sport tyre | 29,00 EUR |
| 2 |  | 30403000 | Tyre MICHELIN S83, Classic, 3.00-10", 42J, KBA 51612, mounted on rim: SIP 2.0 2.10 -10", tubeless, aluminium, polished, mounted, ready to go! | 119,00 EUR |
| 2 |  | 30315030 | Tyre SIP Performer, 3.00-10", 50P, mounted on rim: SIP 2.15-10, tubeless, aluminium, silver matt, mounted, ready to go, up to 150km/h sport tyre | 119,00 EUR |
| 2 |  | 30705040 | Tyre SIP Classic, 3.00-10", 50P, mounted on rim: SIP 2.15-10, tubeless, aluminium, matt black with polished edge, mounted, ready to go, up to 150km/h classic tyre | 119,00 EUR |
| 2 |  | 30315020 | Tyre SIP Performer, 3.00-10", 50P, mounted on rim: SIP 2.15-10, tubeless, aluminium, silver, mounted, ready to go, up to 150km/h sport tyre | 119,00 EUR |
| 2 |  | 88016000 | Tyre MICHELIN STARCROSS MS3, 2.75-10", 37J, TT, M/C, profile: all-terrain, cross tyre | 45,00 EUR |
| 2 |  | 88091000 | Tyre MICHELIN ACS, Classic 2.75-9", 35J, TT, profile: classic, classic tyre | 38,00 EUR |
| 2 |  | 30705010 | Tyre SIP Classic, 3.00-10", 50P, mounted on rim: SIP 2.15-10, tubeless, aluminium, polished, mounted, ready to go, up to 150km/h classic tyre | 119,00 EUR |









| | | | | |
|---|---|-----------|---|------------|
| 2 |  | 30706110 | Tyre SIP Classic, 3.00-10", 50P, ECE-R75, KBA 51612, mounted on rim: SIP 2.0 2.10 -10", tubeless, aluminium, red, mounted, ready to go, up to 150km/h classic tyre | 109,00 EUR |
| 2 |  | 79580000 | Whitewall Tyre KENDA K333, 3.00-10", 42J, TT, profile: classic, classic tyre | 39,00 EUR |
| 2 |  | 79591000 | Tyre SIP Perfromer 2.0, 3.50-10", 59P, TL/TT, reinforced, ECE-R75, up to 150 km/h profile: sport, sport tyre | 29,90 EUR |
| 2 |  | J79860000 | Tyre SIP Classic, 3.00-10", 50P, TL/TT, with ECE norm, profile: classic, bargain offer, incl. 3 SIP Classic tyres classic tyre for tuned engines | 89,00 EUR |
| 2 |  | 30404000 | Tyre CONTINENTAL TWIST, 3.00-10", 50M, M/C, reinforced, front, KBA 51612, mounted on rim: SIP 2.0 2.10 -10", tubeless, aluminium, polished, mounted, ready to go! | 119,00 EUR |
| 2 |  | 89970000 | Tyre HEIDENAU K38, Classic 3.00-10", 50J, TT, reinforced, profile: classic, classic tyre | 35,00 EUR |
| 2 |  | 30306000 | Tyre SIP Performer, 3.00-10", 50P, reinforced, ECE-R75, KBA 50133, mounted on rim: SIP 2.0 2.10 -10", tubeless, aluminium, polished, mounted, ready to go, up to 150km/h | 109,00 EUR |
| 2 |  | 80213900 | Tyre HEIDENAU K80 SR, 3.00-10", 50M, TL/TT, reinforced, profile: sport, up to 130 km/h sport tyre | 35,00 EUR |
| 2 |  | 79522500 | Whitewall Tyre SHINKO SR550, 3.50-10", 59J, TT, reinforced, profile: classic, classic tyre | 45,00 EUR |
| 2 |  | 80040000 | Tyre MICHELIN S1, 3.00-10", 50J, TL/TT, profile: sport, sport tyre | 39,00 EUR |
| 2 |  | 79562110 | Tyre MITAS TOURING FORCE-SC, 3.50-10", 51P, TL, profile: sport, sport tyre | 30,00 EUR |
| 2 |  | 30307000 | Tyre SIP Performer, 3.00-10", 50P, reinforced, ECE-R75, KBA 51612, mounted on rim: SIP 2.0 2.10 -10", tubeless, aluminium, black with polished edge, mounted, ready to go, up to 150km/h | 105,00 EUR |

| | | | | |
|---|---|----------|---|------------|
| 2 |  | 79522400 | Whitewall Tyre SHINKO SR550, 3.00-10", 50J, TT, reinforced, profile: classic, classic tyre | 42,00 EUR |
| 2 |  | 79591300 | Tyre SIP Performer 2.0, 3.50-10", 59P, TL/TT, M/C, reinforced, M+S, ECE-R75, up to 150 km/h profile: sport, bargain offer, incl. 3 SIP performer tyres sport tyre | 85,00 EUR |
| 2 |  | 30706040 | Tyre SIP Classic, 3.00-10", 50P, ECE-R75, KBA 51612, mounted on rim: SIP 2.0 2.10 -10", tubeless, aluminium, matt black with polished edge, mounted, ready to go, up to 150km/h classic tyre | 109,00 EUR |
| 2 |  | DU3010 | Tyre DUNLOP ScootSmart, 3.50-10", 51P, TL/TT, M/C, profile: sport, sport tyre | 35,00 EUR |
| 2 |  | 88011000 | Tyre MICHELIN S83, Classic 3.00-10", 42J, TL/TT, profile: classic, classic tyre | 37,00 EUR |
| 2 |  | 79619000 | Tyre KENDA K303, Classic 3.50-10", 51J, TT, profile: classic, classic tyre | 29,00 EUR |
| 2 |  | 30315040 | Tyre SIP Performer, 3.00-10", 50P, mounted on rim: SIP 2.15-10, tubeless, aluminium, matt black with polished edge, mounted, ready to go, up to 150km/h sport tyre | 119,00 EUR |
| 2 |  | 30705030 | Tyre SIP Classic, 3.00-10", 50P, mounted on rim: SIP 2.15-10, tubeless, aluminium, silver matt, mounted, ready to go, up to 150km/h classic tyre | 119,00 EUR |
| 2 |  | 79614000 | Tyre KENDA K701, 3.00-10", 47L, TL, M+S, profile: strongly profiled, all-season tyre | 35,00 EUR |
| 2 |  | 80393600 | Tyre PIRELLI ANGEL SCOOTER, 3.00-10", 50J, TL, reinforced, profile: sport, sport tyre | 39,00 EUR |
| 2 |  | ME2001 | Tyre METZELER ME 1, 3.00-10", 50J, TL, reinforced, profile: sport, sport tyre | 32,00 EUR |
| 2 |  | 30706030 | Tyre SIP Classic, 3.00-10", 50P, ECE-R75, KBA 51612, mounted on rim: SIP 2.0 2.10 -10", tubeless, aluminium, silver matt, mounted, ready to go, up to 150km/h classic tyre | 109,00 EUR |















| | | | | |
|---|---|----------|--|------------|
| 2 |  | 30902100 | Tyre SIP Classic, 3.00-10", 50P, TT, with ECE norm, mounted on rim: 2.10-10" 2 -part, silver, mounted, ready to go, up to 150km/h classic tyre for tuned engines | 69,00 EUR |
| 2 |  | 79790000 | Tyre SIP Performer, 3.00-10", 50P, TL/TT, reinforced, ECE-R75, profile: sport, up to 150 km/h sport tyre | 29,90 EUR |
| 2 |  | 89940000 | Tyre HEIDENAU K50, 3.00-10", 50J, TL/TT, reinforced, profile: sport, sport tyre | 35,00 EUR |
| 2 |  | 30315010 | Tyre SIP Performer, 3.00-10", 50P, mounted on rim: SIP 2.15-10, tubeless, aluminium, polished, mounted, ready to go, up to 150km/h sport tyre | 119,00 EUR |
| 2 |  | 79581000 | Whitewall Tyre KENDA K333, 3.50-10", 51J, TT, profile: classic, classic tyre | 42,00 EUR |
| 2 |  | 80201100 | Tyre HEIDENAU K58 SNOWTEX, 3.00-10", 50J, TL/TT, reinforced, M+S, profile: strongly profiled, winter tyre | 39,00 EUR |
| 2 |  | 79615000 | Tyre KENDA K701, 3.50-10", 56L, TL, M+S, profile: strongly profiled, all-season tyre | 39,00 EUR |
| 2 |  | H1023 | Tyre HEIDENAU K58, 3.50-10", 59M, TT, reinforced, profile: strongly profiled, all-season tyre | 39,00 EUR |
| 2 |  | 30402000 | Tyre CONTINENTAL TWIST, 3.00-10", 50M, M/C, reinforced, front, KBA 50133, mounted on rim: SIP 2.10-10", tubeless, aluminium, black with polished edge, mounted, ready to go! | 119,00 EUR |
| 2 |  | 30401000 | Tyre MICHELIN S83, Classic, 3.00-10", 42J, KBA 51612, mounted on rim: SIP 2.0 2.10 -10", tubeless, aluminium, black with polished edge, mounted, ready to go! | 119,00 EUR |
| 2 |  | 30705020 | Tyre SIP Classic, 3.00-10", 50P, mounted on rim: SIP 2.15-10, tubeless, aluminium, silver, mounted, ready to go, up to 150km/h classic tyre | 119,00 EUR |
| 2 |  | 80400000 | Tyre CONTINENTAL K62 (Zippy 3), Classic 3.00-10", 50J, TT, M/C, reinforced, profile: classic, classic tyre | 37,00 EUR |

| | | | | |
|---|---|-----------|--|------------|
| 2 |  | 88019000 | Tyre SOBEK S1522, 3.00-10", 42J, TT, w/o e-mark, profile: all-terrain, cross tyre | 35,00 EUR |
| 2 |  | 79500000 | Whitewall Tyre CONTINENTAL K62, 3.00-10", 50J, TT, reinforced, profile: classic, classic tyre | 64,00 EUR |
| 2 |  | 30305000 | Tyre SIP Performer, 3.00-10", 50P, reinforced, ECE-R75, mounted on rim: 2.10-10" 2 -part, mounted, ready to go, up to 150km/h | 65,00 EUR |
| 2 |  | 79612000 | Tyre KENDA K771 Cross, 2.75-10", 38J, TT, w/o e-mark, profile: all-terrain, fits all 10" rims, for intermediate terrian cross tyre | 45,00 EUR |
| 2 |  | 30404100 | Tyre CONTINENTAL TWIST, 3.00-10", 50M, M/C, reinforced, rear, KBA 51612, mounted on rim: SIP 2.0 2.10 -10", tubeless, aluminium, polished, mounted, ready to go! | 119,00 EUR |
| 2 |  | 79620100 | Tyre KENDA K711, 3.00-10", 47L, TL, profile: sport, sport tyre | 39,00 EUR |
| 2 |  | J79780000 | Tyre SIP Performer, 3.00-10", 50P, TL/TT, reinforced, ECE-R75, profile: sport, bargain offer, incl. 3 SIP performer tyres sport tyre | 85,00 EUR |
| 3 |  | 81071000 | Inner Tube CONTINENTAL for tyres, 3.00/3.50/4.00/4.10 /90'90/100'80/100'90/110'80 /120'90/130'90-10", valve 90°, Grade B - decent repair | 8,00 EUR |
| 3 |  | 81072000 | Inner Tube MICHELIN for tyres, 3.00/3.50/90'90 /100'80/100'90-10", valve 60° | 9,90 EUR |
| 3 |  | 81077000 | Inner Tube MICHELIN for tyres, 3.00/3.50/90'90 /100'80/100'90-10", valve 90° | 8,90 EUR |
| 3 |  | 81074000 | Inner Tube SIP for tyres, 3.00/3.50/90'90 /100'80/100'90/110'80-10", valve 90°, 55% Butyl, 35% rubber, Grade A - perfect repair | 6,90 EUR |
| 3 |  | 81300000 | Inner Tube HEIDENAU for tyres, 2.50, 2.75-9" | 11,50 EUR |













| | | | | |
|----|---|----------|--|-----------|
| 3a |  | 90994100 | Valve Insert short, VG5, I 19,5 mm | 0,50 EUR |
| 4 |  | 81202000 | Rim narrow half VIGANO for Vespa 50-125/PV/ET3/PK/S/XL /XL2/125 GT-TS/150 GL/GS VS5T/Sprint/V/T4/Rally/PX/PE /Lusso/T5/LML Star/DLX /Deluxe 2T/4T, 2.10-10", open, front & rear, chrome | 12,50 EUR |
| 4 |  | 81203000 | Rim narrow half for Vespa 50-125/PV/ET3/PK/S/XL/XL2/125 GT-TS/150 GL/GS VS5T/Sprint /V/T4/Rally/PX/PE/Lusso/T5 /LML Star/DLX/Deluxe 2T/4T, 2.10-10", open, front & rear, silver | 9,10 EUR |
| 5 |  | 81200000 | Rim wide half SIP for Vespa 50-125/PV/ET3/PK/S/XL/XL2/125 GT-TS/150 GL/GS VS5T/Sprint /V/T4/Rally/PX/PE/Lusso/T5 /LML Star/DLX/Deluxe 2T/4T, 2.10-10", open, front & rear, silver | 10,90 EUR |
| 5 |  | 81201000 | Rim wide half SIP for Vespa 50-125/PV/ET3/PK/S/XL/XL2/125 GT-TS/150 GL/GS VS5T/Sprint /V/T4/Rally/PX/PE/Lusso/T5 /LML Star/DLX/Deluxe 2T/4T, 2.10-10", open, front & rear, chrome | 14,00 EUR |
| 6 |  | 81050260 | Nut 2 K, M8x1,25 mm, hexagonal, 10.9, steel, zinc plated, silver galvanised, AF 12mm, h 19,3mm, SIP, for SIP rim (tubeless), for Vespa (5), for Lambretta (4) Grade AA - for a first-class repair as a very nice accessory | 1,20 EUR |
| 6 |  | 81050240 | Nut 1K, M8x1,25 mm, hexagonal, 10.9, steel, zinc plated, black galvanised, AF 12mm, h 19,3mm, SIP, for SIP rim (tubeless), for Vespa (5), for Lambretta (4) Grade AA - for a first-class repair as a very nice accessory | 1,20 EUR |
| 6 |  | 81050220 | Nut M8x1,25 mm, hexagonal, 10.9, steel, chrome, AF 12mm, h 19,3mm, for SIP rim (tubeless), for Vespa (5), for Lambretta (4) | 1,50 EUR |
| 6 |  | 81050250 | Nut 1K, M8x1,25 mm, hexagonal, 10.9, steel, chrome, AF 12mm, h 19,3mm, SIP, for SIP rim (tubeless), for Vespa (5), for Lambretta (4) Grade AA - for a first-class repair as a very nice accessory | 1,70 EUR |

















| | | | | |
|------|---|----------|---|-----------|
| 6 |  | 81050200 | Nut M8x1,25 mm, hexagonal, 10.9, steel, zinc plated, silver galvanised, AF 12mm, h 19,3mm, for SIP rim (tubeless), for Vespa (5), for Lambretta (4) | 0,90 EUR |
| 6 |  | 81050280 | Nut 2 K, M8x1,25 mm, hexagonal, 10.9, steel, chrome, AF 12mm, h 19,3mm, SIP, for SIP rim (tubeless), for Vespa (5), for Lambretta (4) Grade AA - for a first-class repair as a very nice accessory | 1,70 EUR |
| 6 |  | 81050270 | Nut 2 K, M8x1,25 mm, hexagonal, 10.9, steel, zinc plated, black galvanised, AF 12mm, h 19,3mm, SIP, for SIP rim (tubeless), for Vespa (5), for Lambretta (4) Grade AA - for a first-class repair as a very nice accessory | 1,20 EUR |
| 6 |  | 81050210 | Nut M8x1,25 mm, hexagonal, 10.9, steel, zinc plated, black galvanised, AF 12mm, h 19,3mm, for SIP rim (tubeless), for Vespa (5), for Lambretta (4) | 0,90 EUR |
| 6 |  | 87185000 | Nut Kit M8 mm, 8, steel, zinc plated, AF 13mm, h 6,5mm, 50 pcs | 8,50 EUR |
| 6 |  | 81050230 | Nut 1K, M8x1,25 mm, hexagonal, 10.9, steel, zinc plated, silver galvanised, AF 12mm, h 19,3mm, SIP, for SIP rim (tubeless), for Vespa (5), for Lambretta (4) Grade AA - for a first-class repair as a very nice accessory | 1,20 EUR |
| 6/14 |  | 87180000 | Nut M8 mm, 8, steel, zinc plated, AF 13mm, h 6,5mm | 0,20 EUR |
| 7 |  | 80108000 | Locking Washer NORD-LOCK M8 mm, Ø 13,5x8,7 mm, (th) 2,5mm, Type NL8, zinc plated, 2-parts | 0,80 EUR |
| 7 |  | 80005000 | Spring Washer M8 mm, Ø 8,1x1.. ..4,8 mm, (th) 2mm, spring steel, zinc coated | 0,20 EUR |
| 9a |  | 90950500 | Spare Wheel Holder for 9" rim, open, 4 hole, behind legshields, for Vespa 50 R 75189->/Special/ V5A2T/V5A3T aluminium, silver, incl. nut | 27,00 EUR |
| 9a |  | 90990000 | Spare Wheel Holder for 10" rim, open, behind legshields, for Vespa 50 Special V5B1-3/SS /90 Racer/100 2°/SS/125 Primavera/ET3/125 GT/GTR/TS /150 VGLA-B/GS VS5/GL/Sprint /V aluminium, silver, incl. mounting material, hole distance frame: 62mm | 24,90 EUR |

















| | | | | |
|----|---|----------|---|-----------|
| 9a |  | 22159461 | Spare Wheel Holder MRP for 8" /9"/10" rim, behind legshields, for Vespa 50 Special V5B1-3/SS /90 Racer/100 2°/SS/125 Primavera/ET3/125 GT/GTR/TS /150 VGLA-B/GS VS5/GL/Sprint /V stainless steel, incl. mounting material, hole distance frame = 54-73mm | 59,90 EUR |
| 9a |  | 90951000 | Spare Wheel Holder CUPPINI for 10" rim, open, behind legshields, for Vespa 50 Special V5B1-3/SS/90 Racer /100 2°/SS/125 Primavera/ET3 /125 GT/GTR/TS/150 VGLA-B/GS VS5/GL/Sprint/V zinc coated, incl. mounting material, hole distance frame: 62mm | 27,00 EUR |
| 9a |  | 22159477 | Bracket MRP jerry can, behind legshields, FuelFriend BIG for Vespa 50 Special V5B1-3/SS /90 Racer/100 2°/SS/125 Primavera/ET3/125 GT/GTR/TS /150 VGLA-B/GS VS5/GL/Sprint /V incl. mounting material | 26,90 EUR |
| 9a |  | 90956100 | Spare Wheel Holder for 10" rim, open, behind legshields, for Vespa 50 Special V5B1-3/SS /90 Racer/100 2°/SS/125 Primavera/ET3/125 GT/GTR/TS /150 VGLA-B/GS VS5/GL/Sprint /V aluminium, silver, hole distance frame: 62mm | 29,90 EUR |
| 9a |  | 90950000 | Spare Wheel Holder CUPPINI for 9" rim, open, 4 hole, behind legshields, for Vespa 50 R 75189->/Special/ V5A2T /V5A3T zinc coated, incl. mounting material, hole distance frame: 62mm | 19,90 EUR |
| 9b |  | 90957000 | Spare Wheel Holder for 9/10" rim, closed, behind legshields, for Vespa 50 N/L/R ->752188/S /SR/Sprinter/Revival/90/100 1° silver, with screw grip, incl. mounting material, hole distance frame: 62/77mm | 28,00 EUR |
| 9b |  | 70870600 | Spare Wheel Holder for 9/10" rim, closed, behind legshields, Vintage for Vespa 50 N/L/R ->752188/S/SR/Sprinter /Revival/90/100 1° aluminium, hole distance frame: 58mm | 24,90 EUR |

| | | | | |
|----|---|----------|---|-----------|
| 9b |  | 90954000 | Spare Wheel Holder for 9/10" rim, closed, behind legshields, for Vespa 50 N/L/R ->752188/S/SR/Sprinter/Revival/90/100 1° zinc coated, incl. mounting material, hole distance frame: 62/77mm | 24,90 EUR |
| 9b |  | 70870500 | Spare Wheel Holder PIAGGIO for 9/10" rim, closed, behind legshields, for Vespa 50 N/L/R ->752188/S/SR/Sprinter/Revival/90/100 1° zinc coated, hole distance frame: 62/77mm | 45,00 EUR |
| 9c |  | 90706000 | Spare Wheel Cover "Italy", for tyre 10", artificial leather, green/white/red | 24,90 EUR |
| 9c |  | 90704000 | Spare Wheel Cover "Target" Royal Air Force, for tyre 10", artificial leather, blue/white/red | 39,90 EUR |
| 9c |  | PLS31907 | Spare Wheel Cover for tyre 3.00-10", artificial leather, black, with bag | 32,00 EUR |
| 9c |  | 90861000 | Spare Wheel Cover for tyre 10", artificial leather, dark blue | 47,00 EUR |
| 9c |  | 90862000 | Spare Wheel Cover for tyre 10", artificial leather, white | 47,00 EUR |
| 9c |  | PLS31906 | Spare Wheel Cover for tyre 3.50-10", artificial leather, black, with bag | 32,00 EUR |
| 9c |  | 90936700 | Spare Wheel Cover for 9" tyres, for Vespa 50 N/L/R artificial leather, grey, with bag, as a very nice accessory | 39,00 EUR |
| 9c |  | 90860000 | Spare Wheel Cover PIAGGIO for tyre 10", fabric, grey, cover | 35,00 EUR |
| 10 |  | 90956300 | Rubber spare wheel holder, for Vespa 125/150/Sprint/150 Super (surrogate) fits art. no. 90955600/90956100 | 4,10 EUR |
| 11 |  | 70871000 | Gasket FA spare wheel holder for Vespa V50 N/L/R | 2,80 EUR |
| 13 |  | 70731400 | Spare Wheel Holder Clamp Piece for 9" rim, closed, for Vespa 50 N/R/L for mounting rim | 6,70 EUR |
| 15 |  | 80002000 | Washer M8 mm, Ø 8,4x16 mm, (th) 1,6mm, steel, zinc plated, 140 HV | 0,20 EUR |
| 16 |  | 88830000 | Screw M8x50 mm, hexagonal, AF 13mm, steel, zinc plated, 8.8 | 0,60 EUR |

| | | | | |
|-------|---|----------|---|------------|
| 16 |  | 30081000 | Screw M8x80 mm, exhaust, for Vespa PK/S/XL/XL2, spare wheel holder for Vespa V50/PV/ET3 | 2,50 EUR |
| 16/17 |  | 90958000 | Cover Lip spare wheel holder, for Vespa 50-125/PV/ET3 drilling M7 | 3,10 EUR |
| 17 |  | 88849000 | Screw M8x30 mm, hexagonal, AF 13mm, steel, zinc plated, 8.8, outlet PK50HP | 0,60 EUR |
| 17 |  | 30078000 | Screw M8x25 mm, hexagonal, AF 13mm, steel, zinc plated, 8.8 | 0,60 EUR |
| 18 |  | 88813000 | Screw M8x20 mm, hexagonal, AF 13mm, steel, zinc plated, 8.8 | 0,60 EUR |
| 19 |  | 21631700 | Spare Wheel Holder CUPPINI for 10" rim, open, side panel left, for Vespa PK50-125/S/SS /XL/XL2 chrome, incl. mounting material | 13,20 EUR |
| 21 |  | 12295700 | Spring closing spare wheel cover, for Vespa PK(2) | 0,90 EUR |
| 22 |  | 18808600 | Catch spare wheel cover, for Vespa PK (2) sidepanel for PIAGGIO Bravo /Ciao PX l 27,5 mm | 3,50 EUR |
| 23 |  | 59892000 | Screw M8x14 mm, spare wheel cover, for Vespa PK | 0,70 EUR |
| 24 |  | 89706000 | Hub Cap PASCOLI "High Quality", for floor board, lengthwise, for Vespa 50 SS/90 SS metal, dark blue grounded, w/o mounting screw | 179,00 EUR |
| 24 |  | 89706100 | Hub Cap for floor board, lengthwise, for Vespa 50 SS/90 SS oiled metal, incl. mounting screw | 89,00 EUR |
| 27 |  | 89706500 | Mounting Screw incl. spring PASCOLI for floor board wheel cap, for Vespa 50 SS/90 SS | 24,90 EUR |
| 28 |  | 90952000 | Spare Wheel Holder PASCOLI for 10" rim, open, floor board lengthwise, floor board clamp 1° for Vespa 50SS ->1009/90SS ->1239 also for Vespa 50SS/90SS 2° with screw | 89,00 EUR |
| 29 |  | 90953100 | Spare Wheel Holder for 10" rim, open, floor board lengthwise, floor board clamp 2° for Vespa 50SS 1010->/90SS 1240-> also for Vespa 50SS/90SS 1° steel, zinc coated | 45,00 EUR |

| | | | | |
|----|---|----------|---|------------|
| 29 |  | 90953000 | Spare Wheel Holder PASCOLI for 10" rim, open, floor board lengthwise, floor board clamp 2° for Vespa 50SS 1010->/90SS 1240-> also for Vespa 50SS/90SS 1° zinc coated | 59,00 EUR |
| 30 |  | 90823000 | Reserve Tank legshield, for Vespa all Classic models, approx. 10 L, incl. spare wheel cover | 199,00 EUR |
| 97 |  | 40526800 | Catalogue VESPA 50, V5N1T italian/french/english/german, 83 p., l=297mm, w=210mm | 18,90 EUR |
| 97 |  | 610062M0 | Instruction Manual PIAGGIO Vespa 125 Primavera 1968 Italian | 16,90 EUR |
| 97 |  | 610187M | Instruction Manual PIAGGIO Vespa V50 V5A1T Italian | 16,90 EUR |
| 97 |  | 6110069M | Instruction Manual PIAGGIO Vespa ET3 Primavera 1976 Italian | 16,90 EUR |
| 97 |  | 610071M0 | Instruction Manual PIAGGIO Vespa PK 50 XL Italian | 16,90 EUR |
| 97 |  | 98980000 | Hand Book Haynes "Workshop Manual 59-78" SS90/PV/Sprint /Rally English, 90 p. | 29,00 EUR |
| 97 |  | 98883000 | Hand Book "Vespa Tecnica 3" 1965/1976 Italian, limited edition | 66,00 EUR |
| 97 |  | 610066M0 | Instruction Manual PIAGGIO Vespa 50 - 50 Special - 50 Elestart (2. Series) Italian | 16,90 EUR |
| 97 |  | 620012M | Garage Hand Book PIAGGIO Vespa 50 R/Special/Elestart/90/SS /125 VMA1T/PV/Super/GT/TS /150 Super/Sprint/180 SS/180 -200 Rally Italian, 116 p., black/white incl. exploded views, wiring diagram etc. | 40,00 EUR |
| 97 |  | 98873000 | Hand Book "Vespa Tecnica 3" 1965/1976 German, limited edition | 76,00 EUR |
| 97 |  | 97836150 | Hand Book "Das Vespa Schrauberhandbuch" Smallframe Modelle von 1965-1989 German, 128 p., l=275mm, w=213mm, ca. 500 Farbfotos, gebunden, ISBN 978-3-95843-043-3 | 24,99 EUR |

| | | | | |
|-----|---|----------|---|------------|
| 97 |  | 97836160 | Hand Book "How to restore Classic Smallframe Vespa Scooters" Smallframe Modelle von 1963 bis 1986 English, 120 p., l=270mm, w=207mm, c. 688 illustrations, hardback, ISBN 978-1-845844-37-0 | 35,00 EUR |
| 97 |  | 610064M0 | Instruction Manual PIAGGIO Vespa 50 - 50 Special (1. Series) Italian | 16,90 EUR |
| 97 |  | 98876000 | Hand Book "Vespa Tecnica 3" 1965/1976 English, limited edition | 77,00 EUR |
| 97 |  | 610046M | Instruction Manual PIAGGIO Vespa SS90 Italian | 18,90 EUR |
| 97 |  | 99412000 | Hand Book Klassische VESPA Motorroller - alle PK, PX, Cosa seit 1970" technics, service, repairs German, 224 p., 650 colour photos and illustrations, 15th edition | 16,90 EUR |
| 98 |  | 14235000 | Brake Cleaner SIP 500ml, spray | 4,50 EUR |
| 98 |  | 81052000 | Airstop Spray MOTUL "Tyre Pilot", "MC CARE P3 TYRE REPAIR", 300ml, for Scooter, Quad and Motorbike tyres | 12,90 EUR |
| 98 |  | 14230000 | Brake Cleaner MASTERCARE /REPSTAR 500ml, spray | 3,50 EUR |
| 98 |  | 14082100 | Tyre Fitting Paste allround mounting paste, 1000g | 14,90 EUR |
| 98 |  | 14082200 | Tyre Fitting Paste DRC 40g, includes a sponge for application | 6,90 EUR |
| 99 |  | 49691000 | Tyre Demounting Tool PLC for tire change, for 10" models Grade A - perfect repair | 49,00 EUR |
| 99A |  | 15214000 | Tyre Fitting Tool BUZZETTI L=500 mm, with plastic cover | 21,20 EUR |
| 99A |  | 15213000 | Tyre Fitting Tool BUZZETTI L=380 mm, with plastic cover | 16,50 EUR |
| 99A |  | 15212000 | Tyre Fitting Tool BUZZETTI L=370 mm, bent | 11,90 EUR |
| 99A |  | 49690000 | Tyre Demounting Tool for changing all tubeless tires, all sizes! | 197,00 EUR |
| 99A |  | 15210000 | Tyre Fitting Tool BUZZETTI L=200 mm | 7,30 EUR |

| | | | | |
|-----|---|----------|--|------------|
| 99A |  | 15211000 | Tyre Fitting Tool BUZZETTI L=350 mm, bent | 11,50 EUR |
| 99A |  | 14231100 | Rim Cleaner SONAX XTREME, PLUS, 500ml, spray bottle | 16,90 EUR |
| 99B |  | 20837529 | Set of Socket Spanners MINI 1/4", chrome-vanadium-steel, 160x8.. ..2x32 mm, plastic case, 23 pieces | 45,00 EUR |
| 99B |  | 90980000 | Tool Kit for PIAGGIO/Vespa all models flat/phillips headed screwdriver, spark plug key 21/13, incl. bag | 19,50 EUR |
| 99B |  | 70932000 | Mini Foot Air Pump BIKERS DREAM aluminium, with analogue monometer | 36,90 EUR |
| 99B |  | 20837525 | Set of Socket Spanners JMP 1/4" + 1/2", chrome-vanadium-steel, plastic case, 82 parts | 149,00 EUR |
| 99B |  | CR432547 | Tool Box 25-piece | 19,90 EUR |
| 99B |  | MXMG05L | Gloves Mechanix The Original, black, unisex, size L, 60% nylon, 35% polyurethan, 5% elastane | 29,90 EUR |
| 99B |  | 20837520 | Screw Driver Set JMP slotted: 5mm/6mm/8mm, phillips: PH1/PH2/PH3, 6 parts | 35,00 EUR |
| 99B |  | 15211100 | Rim Protectors for Tyre Fitting 2 pcs | 8,90 EUR |
| 99B |  | 20837516 | Torque Key JMP 1/4", 5-25 Nm L=335 mm | 70,00 EUR |
| 99B |  | 61627000 | Socket Wrench "Mini" 1/4", length grip: 50mm | 35,00 EUR |
| 99B |  | 12194000 | Knee Pad SIP 435x195x30 mm, foam EVA, black /red | 10,20 EUR |
| 99B |  | 20837515 | Torque Key JMP 3/8", 20-110 Nm L=403 mm | 70,00 EUR |
| 99B |  | 20837522 | Combination Wrench Set JMP chrome-vanadium-steel, 6,7,8.. ,9,10,11,12,13,14,17,19,22 mm, 12-parts | 57,00 EUR |
| 99B |  | 90982000 | Tool Kit wrench 7/8 8/11 regular, phillips screwdriver, spark plug wrench 21/13 | 15,00 EUR |
| 99B |  | 90970410 | Tool Bag SIP Classic, 640 mm, 270 cm, nylon, black, empty, w/o tools Grade AA - for a first-class repair | 29,00 EUR |

| | | | | |
|-----|---|-----------|--|-----------|
| 99B |  | 20837521 | Open-End Wrench Set JMP chrome-vanadium-steel, 6/7, 8 /9, 10/11, 12/13, 14/15, 16 /17, 18/19, 20/22 mm, 8-parts | 35,00 EUR |
| 99B |  | 20837519 | Set of Socket Spanners JMP 1/2", chrome-vanadium-steel, plastic case, 29 parts | 99,00 EUR |
| 99B |  | RB1600053 | Air Pump RacingBros for shock absorber, "Hurricane", digital, 0-20 Bar/0-300 Psi | 59,00 EUR |
| 99B |  | 20837517 | Allen Wrench Set JMP 1,5/2/2,5/3/4/5/6/8/10 mm, with ball end, 9 parts | 27,00 EUR |
| 99B |  | 20837518 | Set of Socket Spanners JMP 1/4", chrome-vanadium-steel, plastic case, 46 parts | 85,00 EUR |
| 99B |  | 20837523 | Pliers Set KNIPEX universal pliers/wire cutter /water pump pliers, 3 parts | 75,00 EUR |
| 99B |  | 12194100 | Floor Mat SIP 3 in 1 1210x420x30 mm, foam EVA, black/red, knee pad, cushion and floor mat all in one | 24,90 EUR |