

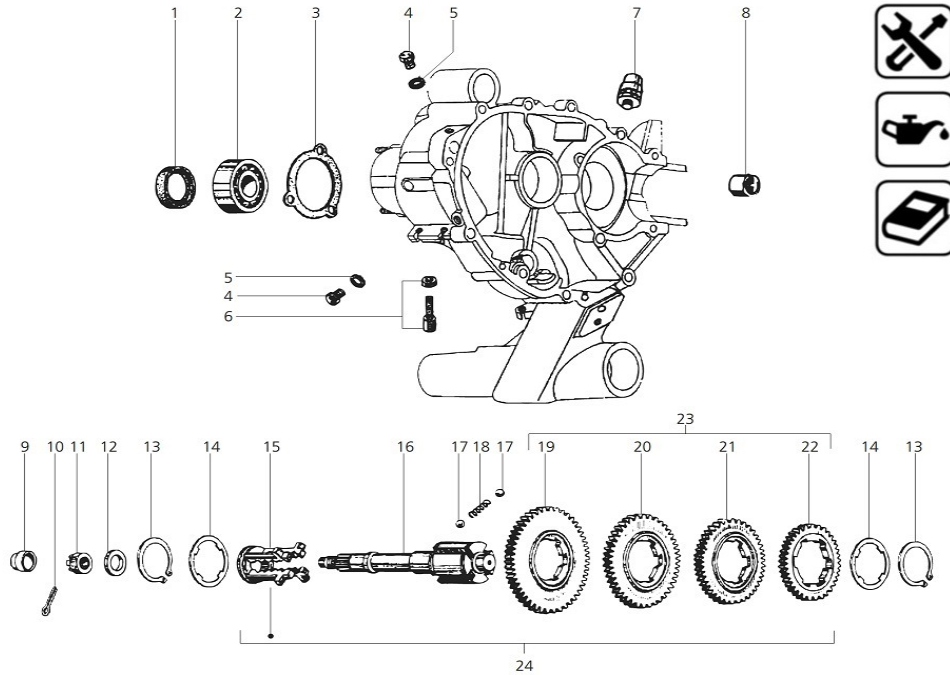







T06 Gear Box - Drive Shaft













		Prod.no.	Product name	Gross Price
1		M6617438	Oil Seal driveshaft for Vespa 50-125/PV/ET3/PK/XL /XL2/125 VNA/VNB/GT 1°/GTR 1°/150 VBA/VBB/VGLA/B/GL /Sprint 1°/V 1°/180 Rally, MALOSSSI, FKM/PTFE, 27x37x7 mm, black	12,00 EUR
1		46599000	Oil Seal driveshaft for Vespa 50-125/PV/ET3/PK/XL /XL2/125 VNA/VNB/GT 1°/GTR 1°/150 VBA/VBB/VGLA/B/GL /Sprint 1°/V 1°/180 Rally, KOK, 27x37x7 mm, black	4,00 EUR
1		46598000	Oil Seal driveshaft for Vespa 50-125/PV/ET3/PK/XL /XL2/125 VNA/VNB/GT 1°/GTR 1°/150 VBA/VBB/VGLA/B/GL /Sprint 1°/V 1°/180 Rally, CORTECO, 27x37x7 mm, blue	4,90 EUR
2		43473700	Bearing driveshaft wheel side for Vespa PX80-200 E Lusso 2° /98/MY/11/T5/Cosa, for PIAGGIO Hexagon/SKR/TPH for LML Star 125-150 2T/4T /Star 125 Deluxe/II Automatica/CVT SKF, smooth-running bearing, E2.6204-2Z/C3, 20x47x14 mm, capsuled, Grade A - perfect repair	16,90 EUR
2		90032000	Bearing driveshaft wheel side for Vespa 50-125/PV/ET3/PK/XL /XL2/125 VNA-TS/150 VBA -Super/Rally/PX80-200/PE /Lusso 1°, inner for Vespa 125 VN2T 2° /150 VL3T/VB1/VGL1/GS/T1-T3 SKF, CN, 20x47x14 mm	9,70 EUR





2		90030000	Bearing Crankshaft flywheel side for Vespa 50 2°/N/L/R/S 2° /Special/SR/SS/PK50/S/SS/XL /XL2/Ape 50, drive shaft wheelside for Vespa 50-125/PV/ET3/PK/XL/XL2 /125 VNA-TS/150 VBA-Super /Rally/PX80-200/PE/Lusso 1° crankshaft for MINARELLI SKF, C3, 20x47x14 mm	9,50 EUR
2		M6611566B	Bearing crankshaft flywheel side for Vespa 50 2°/N/L/R/S 2° /Special/SR/SS/PK50/S/SS/XL /XL2/Ape 50, drive shaft wheelside for Vespa 50-125/PV/ET3/PK/XL/XL2 /125 VNA-TS/150 VBA-Super /Rally/PX80-200/PE/Lusso 1° MALOSSI MHR, C3H, with polyamide cage, 20x47x14 mm, Ø ball: 9,525mm	11,90 EUR
2		6204C4	Bearing Crankshaft for MINARELLI 50cc drive shaft wheelside for GILERA/PIAGGIO 50-180ccm for Vespa 50-125/PV/ET3/PK/XL /XL2/125 VNA-TS/150 VBA -Super/Rally/PX80-200/PE /Lusso 1° SKF, C4, 20x47x14 mm	10,90 EUR
2		43473500	Bearing driveshaft wheel side for Vespa PX80-200 E Lusso 2° /'98/MY/'11/T5/Cosa, for PIAGGIO Hexagon/SKR/TPH for LML Star 125-150 2T/4T /Star 125 Deluxe/II Automatica/CVT SKF, C4, 20x47x14 mm, capsuled	11,50 EUR
2		43473600	Bearing driveshaft wheel side for Vespa PX80-200 E Lusso 2° /'98/MY/'11/T5/Cosa, for PIAGGIO Hexagon/SKR/TPH for LML Star 125-150 2T/4T /Star 125 Deluxe/II Automatica/CVT SKF, CN, 20x47x14 mm, capsuled	11,00 EUR
2		M6616065B	Bearing crankshaft flywheel side for Vespa 50 2°/N/L/R/S 2° /Special/SR/SS/PK50/S/SS/XL /XL2/Ape 50, drive shaft wheelside for Vespa 50-125/PV/ET3/PK/XL/XL2 /125 VNA-TS/150 VBA-Super /Rally/PX80-200/PE/Lusso 1° MALOSSI MHR, C4, with polyamide cage, 20x47x14 mm, Ø ball: 7,938mm	15,90 EUR
3		90899100	Gasket brake base plate for Vespa 50-125/PV/ET3/PK50-125/S /XL/XL2	1,60 EUR











3		78682100	Gasket SIP PREMIUM brake base plate for Vespa 50 N/S/90 1° Serie aramid fiber	2,50 EUR
3		78682000	Gasket brake base plate for Vespa 50 N/S/90 1° Serie	1,90 EUR
3		90899200	Gasket SIP PREMIUM brake base plate for Vespa 50-125/PV/ET3 /PK50-125/S/XL/XL2 aramid fiber	2,10 EUR
4		94355000	Screw / Bolt Kit M8x8 mm, hexagonal, AF 11mm, stainless steel, incl. gaskets oil filler/oil drain, GRAND -SPORT, for Vespa 50-125/PV/ET3/PK/S /XL/XL2/125 VNA-TS/150 VBA -Super/Rally/PX80-200/PE /Lusso/T5/Cosa, screw oil drain magnetic	14,50 EUR
4		94350000	Bolt Oil Inlet/Outlet M8x8 mm, hexagonal, AF 11mm, with Olio lettering oil filler, PIAGGIO, for Vespa 50-125/PV/ET3/PK/S /XL/XL2/125 V1-TS/150 VL -Super/160 GS/180 SS/Rally, (1), oil drain for Vespa 50-125/PV /ET3/PK/S/XL/XL2/125 VNA-TS /150 VBA-Super/Rally/PX80 -200/PE/Lusso/T5/Cosa, (1), Grade A - for a true to original repair	1,70 EUR
5		39701000	Sealing Ring oil filler screw, for Vespa all models, oil drain for Vespa 50-125/PV /ET3/PK/S/XL/XL2/125 VNA-TS /150 VBA-Super/Rally/PX80 -200/PE/Lusso/T5/Cosa	0,70 EUR
6		94240000	Adjusting Screw M5x30 mm, hexagonal, AF 8mm, clutch cable/gear/brake (front)/throttle, RMS, for Vespa V50/PV/ET3/PK/S/XL /XL2/FL/PX/(T5, Cosa1), (0), for Vespa 125 VNB-TS/150 VBA -Super/160 GS/180 SS/Rally, (0), for LML Star 125-200 2T/4T /Deluxe 2T/4S/Speedy/Stella (0), Grade A - perfect repair	1,50 EUR
7		93190000	Ventilation Screw clutch cover, for Vespa V50/PV/ET3/PK/S/XL /XL2/FL/VNA-PX/T5/Cosa, Grade C - low-priced repairs	5,30 EUR
8		71890000	Bearing driveshaft flywheel side for Vespa 50 1° V5A1T -> 92876 /S 1° V5SA1T -> 15324/90 1° V9A1T -> 25000, INA, 16x20x10 mm, needle bearing	7,40 EUR

8		71880000	Bearing driveshaft flywheel side for Vespa 50 N 2°/L/R/S 2°/SR /SS/90 2°/100/125/PV/ET3 /PK50-125/XL/XL2, 16x22x12 mm, needle bearing	7,50 EUR
8		M6615717	Bearing driveshaft flywheel side for Vespa 50 N 2°/L/R/S 2°/SR /SS/90 2°/100/125/PV/ET3 /PK50-125/XL/XL2, MALOSS I, 16x22x12 mm, needle bearing	12,90 EUR
9		87230000	Locking Washer brake drum, for Vespa 50 S 3°/Special V5B3T 2°/90 3°/100 2°/125 PV 2°/ET3 2°/PK50/S/SS/XL/2/FL /HP/N/Rush/PK80-125S/PK125 /ETS/N/XL/XL2//PX80-150 E 2° /P150S 2°/P200E 2°/PX80-200 E Lusso/'98/MY/'11/T5/Cosa brake drum rear for GILERA /PIAGGIO 50-500cc Grade B - decent repair	3,00 EUR
9		19442300	Locking Washer brake drum, PIAGGIO for Vespa 50 S 3° /Special V5B3T 2°/90 3°/100 2°/125 PV 2°/ET3 2°/PK50/S /SS/XL/2/FL/HP/N/Rush/PK80 -125S/PK125/ETS/N/XL/XL2/ /PX80-150 E 2°/P150S 2° /P200E 2°/PX80-200 E Lusso /'98/MY/'11/T5/Cosa brake drum rear for GILERA /PIAGGIO 50-500cc Grade A - perfect repair	4,70 EUR
10		87240000	Cotter Pin brake drum, rear, for Vespa 50-125/PV/ET3/PK/XL /XL2/125 VN-TS/150 VL-Super /160 GS/180 SS/Rally/PX80 -200/PE/Lusso/T5/Cosa front for Vespa 50 R 2°-125/PV /ET3/PK50/S/SS/XL/XL2/125 Super 2°/TS/150 GL/VGLA/B /Sprint/V/Super 2°/160 GS /180 SS/Rally/P150S 3,2x50 mm, steel, zinc plated	0,60 EUR
11		23140000	Castle Nut M14x1,5 mm, black, AF 22mm, SIP, brake drum, rear, 50-125/PV/ET3/125 VN-TS/150 VL -Super/160 GS/180 SS/Rally /P80-150X/PX80-150 E 1° /P150S 1°/P200E 1°, front 50 R 2°-125/PV/ET3/PK50 /S/SS/XL/XL2/125 Super 2°/TS /150 GL/VGLA/B/Sprint/V /Super 2°/160 GS/180 SS /Rally/P150S, Grade A - perfect repair	2,40 EUR

11		87200000	Nut M16 mm, AF 24mm, h 13,0mm, RMS, brake drum, rear, for Vespa 50 S 3°/Special V5B3T 2°/90 3°/100 2°/125 PV 2°/ET3 2°/PK50/S/SS/XL2/FL/HP/N/Rush/PK80-125S/PK125/ETS/N/XL/XL2//PX80-150 E 2°/P150S 2°/P200E 2°/PX80-200 E Lusso/'98/MY/'11/T5/Cosa, for GILERA/PIAGGIO 50-180ccm	2,40 EUR
12		18398000	Spacer brake drum, rear, for Vespa 50 S 3°/Special V5B3T 2°/90 3°/100 2°/125 PV 2°/ET3 2°/PK50/S/SS/XL2/FL/HP/N/Rush/PK80-125S/PK125/ETS/N/XL/XL2 h 7,0 mm, Ø 31,5mm, Øi 16,5 mm	4,00 EUR
12		15005100	Spacer brake drum, rear, for Vespa 50 2°/L/R 1°/S 2°/Special V5B2/3 1°/4T/SR/SS/90 2°/100 1°/125/PV 1°/ET3 1° h 8,5 mm, Ø 31,5mm, Øi 14,5 mm, steel, bronzed, Grade A - perfect repair	3,90 EUR
12		15930000	Spacer brake drum, rear, for Vespa 50 1°/R 2°/S 1°/Special V5A2/3T/90 1°/125 VM/VN/VNA/VNB/GT/GTR/TS/150 VL/VB1/VBA/VBB/VD/VGLA/B/1/GL/Sprint/V/Rally/P80-150X/PX80-150 E 1°/P150S 1°/P200E 1° h 4,0 mm, Ø 27,0mm, Øi 14 mm	1,40 EUR
13		8737J000	Cluster Circlip gear box, for Vespa 50 1°/S 1°/90 1°/125 VM-TS/150 VL-Super/160 GS/180 SS/Rally/P80-150X/P150S/PX80-200 E/PX80-200 E Lusso 1° h 1,75 mm, Ø 43 mm	2,40 EUR
13		59010000	Cluster Circlip drive shaft, for Vespa 50 2°/L/R/S 2°/SR/SS/90 2°/100/125/PV/ET3/PK50-125/XL/XL2 h 1,7 mm, Ø 44,5 mm	2,40 EUR
13		87371000	Cluster Circlip DRT gear box, for Vespa 50 1°/S 1°/90 1°/125 VM-TS/150 VL-Super/160 GS/180 SS/Rally/P80-150X/P150S/PX80-200 E/PX80-200 E Lusso 1° h 1,5 mm, steel, reinforced, Grade AA - for a first-class repair for tuned engines	7,40 EUR
14		13839000	Spacer gear box, SIP (th) 0,90mm, for Vespa 50 2°/L/R/S 2°/SR/SS/90 2°/100/125/PV/ET3/PK50-125/XL/XL2/PX80-200 E Lusso 2°/'98/MY/'11/T5/Cosa also for LML Star 125-200 2T/4T/Deluxe 2T/4S/Speedy/Stella, steel CK75, 4 pins Grade AA - for a first-class repair for tuned engines	5,90 EUR









14		13839300	Spacer gear box, PIAGGIO (th) 1,00mm, for Vespa 50 2°/L/R/S 2°/SR/SS /90 2°/100/125/PV/ET3/PK50 -125/XL/XL2/PX80-200 E Lusso 2°/'98'MY/'11/T5/Cosa also for LML Star 125-200 2T /4T/Deluxe 2T/4S/Speedy /Stella, 4 pins Grade C - low-priced repairs	3,90 EUR
15		13490210	Gear Selector RMS "4-gear PK" for Vespa 50 S 3°/Special V5B3 -4T 2°/SR (D)/100 2°/125 PV 2°/ET3 2°/PK50-125/S/XL/XL2 h 50,2 mm, Ø 42 mm, round, 4-arms	39,00 EUR
15		67167400	Gear Selector POLINI "4-gear" for Vespa 50 S 2°/Special V5B3 -4T 1°/SR/SS/90 R/SS/125/PV 1°/ET3 1° 51 mm, square, 4-arms SPORT-TUNING, high-performance & roadworthy	99,00 EUR
15		67162600	Gear Selector MALOSSSI "4-gear PK" for Vespa 50 S 3°/Special V5B3-4T 2°/SR (D)/100 2°/125 PV 2°/ET3 2°/PK50-125/S/XL /XL2 h 50,2 mm, Ø 42 mm	149,00 EUR
15		40431980	Gear Selector BENELLI "4-gear PK" for Vespa 50 S 3°/Special V5B3-4T 2°/SR (D)/100 2°/125 PV 2°/ET3 2°/PK50-125/S/XL /XL2 round, Grade AA - for a first-class repair for tuned engines	119,00 EUR
15		78942000	Gear Selector PIAGGIO "3-gear" for Vespa 50 1° V5A1T -> 92876 /90 1° V9A1T -> 25000 2-arms	92,00 EUR
15		78942500	Gear Selector DRT "3-gear" for Vespa 50 1° V5A1T -> 92876 /90 1° V9A1T -> 25000 2-arms	79,00 EUR
15		4043175	Gear Selector DRT "4-gear PK" for Vespa 50 S 3°/Special V5B3 -4T 2°/SR (D)/100 2°/125 PV 2°/ET3 2°/PK50-125/S/XL/XL2 Ø 50,2 mm, hardened, with spring, 4-arms, incl. distance washer	79,00 EUR
15		16530400	Gear Selector "3-gear" for Vespa 50 2°/L/R/Special V5A1 -3T/V5B1-2T/90 2°/100/PK50 XL HP/N/Rush 4-arms	49,00 EUR
15		16530150	Gear Selector "3-gear" for Vespa 50 1° V5A1T -> 92876/90 1° V9A1T -> 25000 2-arms	69,00 EUR

15		16530500	Gear Selector DRT "3-gear" for Vespa 50 2°/L/R/Special V5A1-3T/V5B1-2T/90 2°/100 /PK50 XL HP/N/Rush 4-arms for tuned engines Grade A - perfect repair	82,00 EUR
15		13490200	Gear Selector FA "4-gear PK" for Vespa 50 S 3°/Special V5B3 -4T 2°/SR (D)/100 2°/125 PV 2°/ET3 2°/PK50-125/S/XL/XL2 h 50,2 mm, Ø 42 mm, round, 4-arms, incl. spring and ball	45,00 EUR
15		67167300	Gear Selector POLINI "4-gear PK" for Vespa 50 S 3°/Special V5B3-4T 2°/SR (D)/100 2°/125 PV 2°/ET3 2°/PK50-125/S/XL /XL2 h 50,2 mm, Ø 42 mm, SPORT-TUNING, high-performance & roadworthy	87,35 EUR
15		4043175A	Gear Selector DRT "4-gear" for Vespa 50 S 2°/Special V5B3 -4T 1°/SR/SS/90 R/SS/125/PV 1°/ET3 1° l 51 mm, hardened, square, 4-arms	85,00 EUR
15		11158900	Gear Selector CIF "4-gear" for Vespa 50 S 2°/Special V5B3 -4T 1°/SR/SS/90 R/SS/125/PV 1°/ET3 1° 51 mm, square, 4-arms	47,00 EUR
15		40431970	Gear Selector CRIMAZ "4-gear PK" for Vespa 50 S 3°/Special V5B3-4T 2°/SR (D)/100 2°/125 PV 2°/ET3 2°/PK50-125/S/XL /XL2 l 48,8 mm, round, incl. spring for tuned engines	126,00 EUR
15		11158960	Gear Selector PIAGGIO "4-gear" for Vespa 50 S 2°/Special V5B3 -4T 1°/SR/SS/90 R/SS/125/PV 1°/ET3 1° 51 mm, square, 4-arms	72,00 EUR
15		11200700	Gear Selector PIAGGIO "3-gear" for Vespa 50 2°/L/R/Special V5A1-3T/V5B1-2T/90 2°/100 /PK50 XL HP/N/Rush 4-arms	92,00 EUR
15		16530160	Gear Selector "4-gear" for Vespa 50 S V5SA1T ->15324 2-arms	59,00 EUR
15		40431900	Gear Selector BFA MOTORI "4 -gear PK" for Vespa 50 S 3° /Special V5B3-4T 2°/SR (D) /100 2°/125 PV 2°/ET3 2° /PK50-125/S/XL/XL2 l 50,2 mm, hardened, round, 4-arms	142,00 EUR

16		11159000	Driveshaft BFA MOTORI "4-gear" for Vespa 50 2°/N 2°/L/R/S /Special/SR/SS/90 2°/100/125 /PV/ET3/PK50-125/S/XL/XL2 RACE-TUNING, for professionals Grade AA - first-class repair	179,00 EUR
16		11161000	Driveshaft CRIMAZ "4-gear" for Vespa 50 2°/N 2°/L/R/S /Special/SR/SS/90 2°/100/125 /PV/ET3/PK50-125/S/XL/XL2 Grade AA - for a first-class repair for tuned engines	209,00 EUR
16		11159600	Driveshaft "4-gear" for Vespa 50 2°/N 2°/L/R/S/Special/SR/SS /90 2°/100/125/PV/ET3/PK50 -125/S/XL/XL2 16mm thread, art. no. 872000 /872300/8724/183980 necessary	79,00 EUR
16		11160000	Driveshaft BENELLI "4-gear" for Vespa 50 2°/N 2°/L/R/S /Special/SR/SS/90 2°/100/125 /PV/ET3/PK50-125/S/XL/XL2 Grade AA - for a first-class repair for tuned engines	209,00 EUR
17		63790000	Ball gear selector, for Vespa 50-125/PV/ET3/PK/XL/XL2	1,40 EUR
18		15011500	Spring gear selector, for Vespa 50-125/PV/ET3/PK/XL/XL2 6,5x36,4 mm, reinforced SPORT-TUNING, high-performance & roadworthy	3,60 EUR
18		15011700	Spring CRIMAZ gear selector, for Vespa 50-125/PV/ET3/PK/XL /XL2 6,8x33 mm, reinforced SPORT-TUNING, high-performance & roadworthy Grade A - perfect repair	5,90 EUR
18		15011000	Spring gear selector, for Vespa 50-125/PV/ET3/PK/XL/XL2 7x36 mm, standard Grade A - perfect repair	2,40 EUR
18		40431990	Spring Kit BFA MOTORI gear selector, for Vespa 50-125 PV /ET3/PK/XL/XL2 6,8x33 mm, incl. ball, reinforced RACE-TUNING, for professionals Grade A - perfect repair	7,90 EUR
19		40431710	Gear Cog 55 teeth, 1st gear, DRT "4-gear/PK" ROVIGO, for Vespa 50 S 2°/Special V5B3-4T /SR/SS/90 R/SS/100 2°/125/PV /ET3/PK50/S/SS/XL/2/FL/PK80 -125 S/PK125/ETS/N//XL/XL2, Ø 121,9 mm, h 9 mm, mid section: 4,25mm, "tall 1st gear"	107,00 EUR











19		13490300	Gear Cog 58 teeth, 1st gear, "4-gear PK" for Vespa 50 S 3° /Special V5B3T 3°/V5B4T 2° /SR (D)/100 2°/125 PV 2°/ET3 2°/PK50/S/SS/XL/2/FL/PK80 -125 S/PK125/ETS/N//XL/XL2, Ø 122 mm, h 8,9 mm, mid section: 3,9mm	52,00 EUR
19		11201800	Gear Cog 60 teeth, 1st gear, for Vespa V50 S 1°, 3-Gang, Ø 121,4 mm, h 13 mm, mid section: 6,6mm	40,00 EUR
19		40432220	Gear Cog 55 teeth, 1st gear, DRT "3-gear" for Vespa 50/N/L /R/Special V5A2/3/V5B1/2/90 /100/PK 50XL FL/HP/N/Rush /PK100 S, Ø 121,4 mm, h 12 mm, "tall 1st gear"	112,00 EUR
19		16545740	Gear Cog 59 teeth, 1st gear, for Vespa 50 S 4°/PK50 SS/Ape TL2 2°-TL6, Ø 123 mm, h 10,3 mm, mid section: 4,1mm	41,00 EUR
19		15283500	Gear Cog 58 teeth, 1st gear, "4-gear" for Vespa 50 S 2° /Special V5B3T 2°/V5B4T 1° /SR 1°/SS/90 R/SS/125/PV 1° /ET3 1°, Ø 122 mm, h 8,9 mm, mid section: 3,9mm	32,00 EUR
19		13438100	Gear Cog 58 teeth, 1st gear, "3-gear" for Vespa 50 2°/N 2° /L/R/Special V5A2/3/V5B1/2 /90 2°/100/PK 50XL FL/HP/N /Rush/PK100 S, Ø 122 mm, h 8,9 mm, mid section: 4,5mm	36,00 EUR
19		40430010	Gear Cog 57 teeth, 1st gear, DRT "4-gear PK" for Vespa 50 S 3°/Special V5B3T 3°/V5B4T 2°/SR (D)/100 2°/125 PV 2° /ET3 2°/PK50/S/SS/XL/2/FL /PK80-125 S/PK125/ETS/N//XL /XL2, Ø 121,8 mm, h 8,7 mm, mid section: 4,0mm, reinforced	99,00 EUR
20		40431730	Gear Cog 52 teeth, 2nd gear, DRT "4-gear PK" KATANA, for Vespa 50 S 3°/Special V5B3T 3° /V5B4T 2°/SR (D)/100 2°/125 PV 2°/ET3 2°/PK50/S/SS/XL/2 /FL/PK80-125 S/PK125/ETS/N/ /XL/XL2, Ø 113,2 mm, h 9,2 mm, mid section: 4,3mm, "tall 2nd gear"	115,00 EUR
20		43000600	Gear Cog 52 teeth, 2nd gear, "3-gear" for Vespa PK 50 XL HP, Ø 109,5 mm, h 9,2 mm, mid section: 4,2mm	35,00 EUR
20		28717800	Gear Cog 55 teeth, 2nd gear, "3-gear" for Vespa PK 50 XL FL /PK 125 N, Ø 110,6 mm, h 9,3 mm, mid section: 4,3mm	35,00 EUR









20		15283900	Gear Cog 54 teeth, 2nd gear, "4-gear" for Vespa 50 S 2° V5SA1T 22445->69443/Ape 50 TL1/TL2 1°, Ø 111,8 mm, h 9,2 mm, mid section: 4,8mm	30,00 EUR
20		16544940	Gear Cog 54 teeth, 2nd gear, for Vespa 50 S 4°/PK50 SS/Ape TL2 2°-TL6, Ø 112 mm, h 9,2 mm, mid section: 4,2mm, for 4 gear models	79,00 EUR
20		13254700	Gear Cog 54 teeth, 2nd gear, "3-gear" for Vespa 50 2°/N 2° /L/R/Special V5A2/3/V5B1/2 /90 2°/100/PK 50XL FL/HP/N /Rush/PK100 S, Ø 111 mm, h 8,9 mm, mid section: 4,1mm	49,00 EUR
20		4043173A	Gear Cog 55 teeth, 2nd gear, DRT "4-gear PK" for Vespa 50 S 3°/Special V5B3T 3°/V5B4T 2°/SR (D)/100 2°/125 PV 2° /ET3 2°/PK50/S/SS/XL/2/FL /PK80-125 S/PK125/ETS/N//XL /XL2, Ø 112,8 mm, h 8,8 mm, mid section: 4mm, "short 2nd gear"	114,00 EUR
20		40437970	Gear Cog 54 teeth, 2nd gear, DRT "4-gear PK" for Vespa 50 S 3°/Special V5B3T 3°/V5B4T 2°/SR (D)/100 2°/125 PV 2° /ET3 2°/PK50/S/SS/XL/2/FL /PK80-125 S/PK125/ETS/N//XL /XL2, Ø 113,15 mm, h 8,75 mm, mid section: 4,0mm, reinforced	102,00 EUR
20		13490400	Gear Cog 54 teeth, 2nd gear, "4-gear PK" for Vespa 50 S 3° /Special V5B3T 3°/V5B4T 2° /SR (D)/100 2°/125 PV 2°/ET3 2°/PK50/S/SS/XL/2/FL/PK80 -125 S/PK125/ETS/N//XL/XL2, Ø 113 mm, h 8,9 mm, mid section: 4,3mm	49,00 EUR
21		4043177R	Gear Cog 47 teeth, 3rd gear, DRT "3-gear" for Vespa 50/N/L /R/Special V5A2/3/V5B1/2/90 /100/PK 50XL FL/HP/N/Rush /PK100 S, Ø 100,5 mm, h 10,8 mm, 3 gear	109,00 EUR
21		16545040	Gear Cog 49 teeth, 3rd gear, for Vespa 50 S 4°/PK50 SS/Ape TL2 2°-TL6, Ø 100,9 mm, h 9,7 mm, mid section: 4,2mm	72,00 EUR
21		13490500	Gear Cog 50 teeth, 3rd gear, P/A "4-gear PK" for Vespa 50 S 3°/Special V5B3T 3°/V5B4T 2°/SR (D)/100 2°/125 PV 2° /ET3 2°/PK50/S/SS/XL/2/FL /PK80-125 S/PK125/ETS/N//XL /XL2, Ø 104,5 mm, h 9,2 mm, mid section: 3,6mm	59,00 EUR

21		40437220	Gear Cog 50 teeth, 3rd gear, DRT "4-gear PK" for Vespa 50 S 3°/Special V5B3T 3°/V5B4T 2°/SR (D)/100 2°/125 PV 2° /ET3 2°/PK50/S/SS/XL/2/FL /PK80-125 S/PK125/ETS/N//XL /XL2, Ø 104,5 mm, h 9,2 mm, mid section: 3,9mm, "standard 3rd gear"	95,00 EUR
21		78947000	Gear Cog 47 teeth, 3rd gear, "3-gear" for Vespa 50 1° V5A1T -> 92876/90 1° V9A1T -> 25000, Ø 98 mm, h 9,5 mm, mid section: 7mm, 6 cut-outs	40,00 EUR
21		40433150	Gear Cog 49 teeth, 3rd gear, DRT "4-gear PK" for Vespa 50 S 3°/Special V5B3T 3°/V5B4T 2°/SR (D)/100 2°/125 PV 2° /ET3 2°/PK50/S/SS/XL/2/FL /PK80-125 S/PK125/ETS/N//XL /XL2, Ø 104,5 mm, h 9,4 mm, mid section: 4,2mm, "ultra short /short/tall 3rd gear"	89,00 EUR
21		40431640	Gear Cog 48 teeth, 3rd gear, DRT "3-gear" for Vespa 50/N/L /R/Special V5A2/3/V5B1/2/90 /100/PK 50XL FL/HP/N/Rush /PK100 S, Ø 96,9 mm, h 11 mm, mid section: 6,3mm, "short 3rd gear"	89,00 EUR
21		15284000	Gear Cog 49 teeth, 3rd gear, P/A "4-gear" for Vespa 50 S 2° V5SA1T 22445->69443/Ape 50 TL1/TL2 1°, Ø 100,9 mm, h 9,7 mm, mid section: 4,2mm	42,00 EUR
21		13254800	Gear Cog 47 teeth, 3rd gear, "3-gear" for Vespa 50 2°/N 2° /L/R/Special V5A2/3/V5B1/2 /90 2°/100/PK 50XL FL/HP/N /Rush/PK100 S, Ø 98 mm, h 10,5 mm, mid section: 5,8mm	49,00 EUR
22		40431770	Gear Cog 47 teeth, 4th gear, DRT "4-gear PK" PARMA, for Vespa 50 S 3°/Special V5B3T 3° /V5B4T 2°/SR (D)/100 2°/125 PV 2°/ET3 2°/PK50/S/SS/XL/2 /FL/PK80-125 S/PK125/ETS/N/ /XL/XL2, for DRT input shaft NURBURG /SINCRO/MATRIX Ø 100,5 mm, h 9,3 mm, mid section: 7,4mm	114,00 EUR
22		15283800	Gear Cog 46 teeth, 4th gear, "4-gear" for Vespa 50 S 2° /Special V5B3T 2°/V5B4T 1° /SR 1°/SS/90 R/SS/125/PV 1° /ET3 1°, Ø 97 mm, h 9,1 mm, mid section: 4,5mm	42,00 EUR

22		15284100	Gear Cog 43 teeth, 4th gear, "4-gear" for Vespa 50 S 2° V5SA1T 22445->69443/Ape 50 TL1/TL2 1°, Ø 90,9 mm, h 9,5 mm, mid section: 5mm	30,00 EUR
22		13490600	Gear Cog 46 teeth, 4th gear, DRT "4-gear PK" for Vespa 50 S 3°/Special V5B3T 3°/V5B4T 2°/SR (D)/100 2°/125 PV 2° /ET3 2°/PK50/S/SS/XL/2/FL /PK80-125 S/PK125/ETS/N//XL /XL2, Ø 97 mm, h 9,1 mm, mid section: 6,9mm, Grade A - perfect repair	45,00 EUR
22		40437200	Gear Cog 47 teeth, 4th gear, DRT "4-gear PK" for Vespa 50 S 3°/Special V5B3T 3°/V5B4T 2°/SR (D)/100 2°/125 PV 2° /ET3 2°/PK50/S/SS/XL/2/FL /PK80-125 S/PK125/ETS/N//XL /XL2, Ø 96,7 mm	109,00 EUR
22		16545100	Gear Cog 43 teeth, 4th gear, for Vespa 50 S 4°/PK50 SS/Ape TL2 2°-TL6, Ø 90,6 mm, h 9,3 mm, mid section: 7,3mm	85,00 EUR
22		23713400	Gear Cog 44 teeth, 4th gear, for Vespa PK 50 XLS, Ø 92,2 mm, h 9,1 mm, mid section: 7,1mm	41,00 EUR
22		79617000	Gear Cog 43 teeth, 4th gear, for Vespa V50 S 1° Serie, Ø 91 mm, h 9,4 mm, mid section: 7mm	40,00 EUR
24		40433360	Gearbox Kit BENELLI Bull 6-a.. ..rms, for Vespa 50-125/PV/ET3 /PK50-125/S/XL/XL2, incl. gears, 6-arms gear selector, input shaft, drive shaft, with large teeth module RACE-TUNING, for professionals Grade AA - first-class repair	1139,00 EUR
24		13490700	Gearbox Kit 58-54-50-46 teeth, "4-gear PK" for Vespa 50-125 /PV/ET3/PK50-125/S/XL/XL2, for conversion from 3- to 4 -gear incl. gear/gear selector/input shaft 22-19-14-10 teeth	159,00 EUR
24		134907J0	Gearbox Kit 58-54-50-46 teeth, "4-gear PK" for Vespa 50-125 /PV/ET3/PK50-125/S/XL/XL2, for conversion from 3- to 4 -gear incl. gear/gear selector/input shaft 22-19-14-10 teeth	299,00 EUR
97		40526800	Catalogue VESPA 50, V5N1T italian/french/english/german, 83 p., l=297mm, w=210mm	18,90 EUR

97		610062M0	Instruction Manual PIAGGIO Vespa 125 Primavera 1968 Italian	16,90 EUR
97		610187M	Instruction Manual PIAGGIO Vespa V50 V5A1T Italian	16,90 EUR
97		6110069M	Instruction Manual PIAGGIO Vespa ET3 Primavera 1976 Italian	16,90 EUR
97		610071M0	Instruction Manual PIAGGIO Vespa PK 50 XL Italian	16,90 EUR
97		98980000	Hand Book Haynes "Workshop Manual 59-78" SS90/PV/Sprint/Rally English, 90 p.	29,00 EUR
97		98883000	Hand Book "Vespa Tecnica 3" 1965/1976 Italian, limited edition	66,00 EUR
97		610066M0	Instruction Manual PIAGGIO Vespa 50 - 50 Special - 50 Elestart (2. Series) Italian	16,90 EUR
97		620012M	Garage Hand Book PIAGGIO Vespa 50 R/Special/Elestart/90/SS/125 VMA1T/PV/Super/GT/TS/150 Super/Sprint/180 SS/180-200 Rally Italian, 116 p., black/white incl. exploded views, wiring diagram etc.	40,00 EUR
97		98873000	Hand Book "Vespa Tecnica 3" 1965/1976 German, limited edition	76,00 EUR
97		97836150	Hand Book "Das Vespa Schrauberhandbuch" Smallframe Modelle von 1965-1989 German, 128 p., l=275mm, w=213mm, ca. 500 Farbfotos, gebunden, ISBN 978-3-95843-043-3	24,99 EUR
97		97836160	Hand Book "How to restore Classic Smallframe Vespa Scooters" Smallframe Modelle von 1963 bis 1986 English, 120 p., l=270mm, w=207mm, c. 688 illustrations, hardback, ISBN 978-1-845844-37-0	35,00 EUR
97		610064M0	Instruction Manual PIAGGIO Vespa 50 - 50 Special (1. Series) Italian	16,90 EUR
97		98876000	Hand Book "Vespa Tecnica 3" 1965/1976 English, limited edition	77,00 EUR
97		610046M	Instruction Manual PIAGGIO Vespa SS90 Italian	18,90 EUR

97		99412000	Hand Book Klassische VESPA Motorroller - alle PK, PX, Cosa seit 1970" technics, service, repairs German, 224 p., 650 colour photos and illustrations, 15th edition	16,90 EUR
98		14235000	Brake Cleaner SIP 500ml, spray	4,50 EUR
98		14080000	Multi-Purpose Grease REPSTAR 400g	5,50 EUR
98		14100000	Thread Locker LOCTITE "243", medium strength, blue, 5ml	11,20 EUR
98		14230000	Brake Cleaner MASTERCARE /REPSTAR 500ml, spray	3,50 EUR
99A		90829100	Lubricator Squeeze, transparent, 250ml, plastic	5,10 EUR
99A		18119100	Adaptor Kit SIP tool assembly output shaft/ crankshaft, M16x1,25, M14x1,5, M12x1,5, M12x1,25, RH M10x1,5, LH M10x1,5 mm, 6-part	23,50 EUR
99A		21467900	Tool Puller SIP for bearing flywheel/clutch/primary /drive shaft/input shaft flywheel side for Vespa 50-125/PV/ET3/PK 25/20/16/10mm, 50/32 mm, 4 pullers, 12-parts, S45C	169,00 EUR
99A		20781000	Chuck SIP for assembly bearing drive shaft wheel side, for Vespa 50-125/PV/ET3/PK50 -125/S/XL/XL2/125 VNA-TS/150 VBA-Super/Rally/PX80-200/PE /Lusso/'98/MY/'11/T5/Cosa for bearing clutch/primary /input shaft for Vespa 50-125 /PV/ET3/PK50-125/S/XL/XL2 for bearing flywheel for Vespa 50-125/PV/ET3/PK50/S/XL/XL2 /PK80S/PK125/S 1° Ø 47 mm, with hole Ø 21mm	22,90 EUR
99A		21467600	Tool Puller SIP for bearing drive shaft flywheel side for Vespa 50 N 2°/L/R/S 2°/SR /SS/90 2°/100/125/PV/ET3 /PK50-125/XL/XL2 16/32 mm, 1 puller, 4-parts, S45C	49,00 EUR
99A		20837000	Chuck disassembly driveshaft, for Vespa all models Ø16 mm	15,00 EUR

99A		21467270	Tool Puller SIP for bearing shell drive shaft flywheel side for Vespa 50 1° V5A1T -> 92876 /S 1° V5SA1T -> 15324/90 1° V9A1T -> 25000 16/32 mm, 1 puller, 4-parts, S45C	49,00 EUR
99A		60824000	Feeler Gauge SIP spacer gear box, 0,05-0,10-0,20-0,40 mm, stainless steel, for checking axial clearance	29,00 EUR
99A		18118000	Tool SIP driveshaft disassembly, for Vespa 50-125 /PV/ET3/PK50-125/S/XL/XL2 Grade AA - for a first-class repair	45,00 EUR
99A		22480000	Chuck SIP bearing drive shaft wheel side disassembly, for Vespa 50-125/PV/ET3/PK/XL /XL2/125 VNA-TS/150 VBA -Super/Rally/PX80-200/PE /Lusso/'98/MY/'11/T5/Cosa bearing clutch/input shaft /primary disassembly for Vespa 50-125/PV/ET3/PK50-125/S/XL /XL2 41,5 mm, for bearing 20x47x14 /17x47x14/25x47x8	22,00 EUR
99A		63791000	Tool mounting gear selector balls, for Vespa 50-125/PV/ET3/PK50 -125/S/XL/XL2 also for for Lambretta 125 LI/LIS/DL/GP/150 LI/LIS/SX/DL/GP/175 TV/200 TV/SX/DL/GP one pair	16,50 EUR
99A		21468000	Tool Puller SIP for bearing flywheel/clutch/primary /drive shaft/input shaft flywheel side for Vespa 50-125/PV/ET3/PK for bearing flywheel/clutch /gear selector for Vespa PX80 -200/PE/Lusso/T5/Cosa for bearing clutch/flywheel side for Vespa 125 V30-TS/150 VL-Super 29/25/20/16/10mm, 64/50/40/32 mm, 5 pullers, 16-parts, S45C	199,00 EUR
99B		15197300	Circlip Pliers KNIPEX for outer rings Ø 19-60 mm, straight	27,00 EUR
99B		20837529	Set of Socket Spanners MINI 1/4", chrome-vanadium-steel, 160x8.. ..2x32 mm, plastic case, 23 pieces	45,00 EUR
99B		90980000	Tool Kit for PIAGGIO/Vespa all models flat/phillips headed screwdriver, spark pulg key 21/13, incl. bag	19,50 EUR

99B		20837525	Set of Socket Spanners JMP 1/4" + 1/2", chrome-vanadium-steel, plastic case, 82 parts	149,00 EUR
99B		CR432547	Tool Box 25-piece	19,90 EUR
99B		MXMG05L	Gloves Mechanix The Original, black, unisex, size L, 60% nylon, 35% polyurethan, 5% elastane	29,90 EUR
99B		20837520	Screw Driver Set JMP slotted: 5mm/6mm/8mm, phillips: PH1/PH2/PH3, 6 parts	35,00 EUR
99B		15197000	Circlip Pliers JMP with 4 adapters	13,90 EUR
99B		20837516	Torque Key JMP 1/4", 5-25 Nm L=335 mm	70,00 EUR
99B		61627000	Socket Wrench "Mini" 1/4", length grip: 50mm	35,00 EUR
99B		12194000	Knee Pad SIP 435x195x30 mm, foam EVA, black /red	10,20 EUR
99B		20837515	Torque Key JMP 3/8", 20-110 Nm L=403 mm	70,00 EUR
99B		20837522	Combination Wrench Set JMP chrome-vanadium-steel, 6,7,8.. ,9,10,11,12,13,14,17,19,22 mm, 12-parts	57,00 EUR
99B		90982000	Tool Kit wrench 7/8 8/11 regular, phillips screwdriver, spark plug wrench 21/13	15,00 EUR
99B		90970410	Tool Bag SIP Classic, 640 mm, 270 cm, nylon, black, empty, w/o tools Grade AA - for a first-class repair	29,00 EUR
99B		20837521	Open-End Wrench Set JMP chrome-vanadium-steel, 6/7, 8 /9, 10/11, 12/13, 14/15, 16 /17, 18/19, 20/22 mm, 8-parts	35,00 EUR
99B		20837519	Set of Socket Spanners JMP 1/2", chrome-vanadium-steel, plastic case, 29 parts	99,00 EUR
99B		20837517	Allen Wrench Set JMP 1,5/2/2,5/3/4/5/6/8/10 mm, with ball end, 9 parts	27,00 EUR
99B		20837518	Set of Socket Spanners JMP 1/4", chrome-vanadium-steel, plastic case, 46 parts	85,00 EUR
99B		20837523	Pliers Set KNIPEX universal pliers/wire cutter /water pump pliers, 3 parts	75,00 EUR

99B



12194100

Floor Mat SIP 3 in 1
1210x420x30 mm, foam EVA,
black/red,
knee pad, cushion and floor
mat all in one

24,90 EUR